

**WorryFree®**

**REPAIR-REPLACE-PROTECT**



PSE&G **WorryFree®**  
Protection Plans for  
Residential Customers

**Terms and  
Conditions**



**PSE&G**

*We make things work for you.*

## Welcome to PSE&G WorryFree®

You've made a wise decision to purchase a **WorryFree** Protection Plan. As a valued member of our **WorryFree** Program, you'll enjoy the peace of mind that comes with...

- **Dependable coverage** for repair service with no deductibles or labor charges to replace covered parts.†
- **Simple, one-call scheduling** – online or by phone.††
- **No hidden costs** – you'll never pay a fee for a service call for our technician to visit your home to diagnose and repair your covered appliance.
- **Fast response†† for repair work at any time** from New Jersey's largest team of skilled technicians.
- **WorryFree Tech-Talk** – a skilled technician will work to resolve your appliance repair needs over the phone.
- **Reliable, experienced technicians** who carry ID badges and have a proven track record for meeting appointments. What's more, they're backed by a company that's been in business for over 100 years.
- **Convenient monthly payments** that appear right on your PSE&G energy bill.
- **Plus added benefits**, like FREE membership in **Buyer's Edge Inc.™**, a wholesale pricing program.
  - Visit [www.buyersedge.com](http://www.buyersedge.com)  
Username = 1606 Password = member1
  - For pricing: 1-800-377-3700
  - For program details: 1-800-755-5008

This booklet contains important information about appointment scheduling, safety, and **WorryFree** terms and conditions. **Please keep it in a safe place so you can refer to it easily.** Visit [pseg.com/terms](http://pseg.com/terms) for the latest terms and conditions.

Thanks for choosing **WorryFree**. We look forward to serving you!

For questions or to schedule an appliance repair, visit [pseg.com/worryfree](http://pseg.com/worryfree) or call us anytime, day or night, at:

**1-800-350-PSEG (7734)**

*NOTE: PSE&G WorryFree Services are only available to customers located in PSE&G's service territory. Service companies other than PSE&G may provide similar services. A list of those companies may be available from public listings, including telephone directories. Customers are not required to purchase Worry Free services to receive safe, adequate, and proper utility service or to take part in utility energy efficiency programs.*

† Subject to parts availability. Not all parts are covered.

†† Response times will vary by seasonal demands and by the nature of the problem. Plans do not provide priority service, regular maintenance, a guaranteed response time, or annual inspections.

## Table of Contents

<b>Before Your Appointment</b>	<b>4</b>
<b>WorryFree Program Terms, Conditions, and Limitations</b>	<b>5</b>
General Conditions	5
Limitations	6
Protection Plan Renewal	8
Coverage Term	8
Missed or Late Payments	8
Change of Address	8
WorryFree Protection Plan Cancellation	9
General Exclusions	10
<b>Heating Plans</b>	<b>11</b>
Standard Plan – Residential Natural Gas Furnace/Boiler	11
Premier Plan – Residential Hot Water Boiler	11
Residential Natural Gas or Electric Storage-type Water Heaters	16
Residential Natural Gas Tankless-type Water Heater	18
<b>Cooling Plans</b>	<b>19</b>
Residential Electric Central Air Conditioner	19
<b>Heat Pump/Ductless Plans</b>	<b>21</b>
Standard Residential Heat Pump	21
Ductless Heating & Cooling	23
<b>Kitchen Plans</b>	<b>25</b>
Standard Brand Plans	25
Elite Brand Plans	25
Residential Refrigerator	25
Residential Freezer	27
Residential Dishwasher	28
Residential Stove/Range, Cooktop, and Wall Oven	29
<b>Laundry Plans</b>	<b>32</b>
Residential Clothes Dryer	32
Residential Washing Machine	34
<b>Other Home Plans</b>	<b>36</b>
Residential Gas Piping	36
Residential Gas Fireplace	38
Residential Natural Gas Pool Heater	39
Residential Natural Gas Grill	40
<b>Important Safety Information</b>	<b>41</b>
What to Do During a Gas Emergency	41
<b>How to Schedule Repair Service</b>	<b>42</b>

## Before Your Appointment...

Please go through the following checklist, so we can service your appliances safely and efficiently.

- Inform your service technician of any unusual situations, such as loose or broken steps and railings.
- Make sure all walkways are clear of obstructions, including snow and debris.
- Secure all pets outdoors, or in a room away from the work area.
- Ensure safe, unobstructed access to the appliance being serviced.
- Be certain that the area around the appliance is dry, clear, and well lit. *We cannot service an appliance if it is surrounded by standing water.*
- For heating and cooling equipment located in attics, please make sure that...
  - Your access door is at least 20" x 30" in size.
  - All passageways and service areas are covered with solid/secured flooring.
  - A fixed light is installed near the appliance.
  - Your attic can be accessed by a staircase or OSHA-approved ladder of adequate height that you provide.
  - The minimum clearance shall be: 48" between the floor and overhead construction where access is required for servicing or cleaning, and 24" at sides of the appliance where access is required for servicing or cleaning.
- For heating and cooling equipment located in a basement or utility room which is accessible only through a crawl space, ensure that such crawl space shall meet minimum clearance.
  - The access door or other means of entry to the crawl space shall not be less than 22" x 30", and large enough to allow the largest appliance part to enter. The passageway from the point of entry to the service area shall be at least 24" wide and 48" high. The minimum clearance shall be: 48" between the floor and overhead construction where access is required for servicing or cleaning, and 24" at sides of the appliance where access is required for servicing or cleaning.

# WorryFree® Program Terms, Conditions, and Limitations

## General Conditions

- This agreement is between PSE&G and participants in the **WorryFree** Protection Plan for Residential Customers (hereinafter referred to as the “Protection Plans,” “Residential Protection Plans”, or “Program”) for residential-type **natural gas furnaces and boilers; heat pumps; ductless heating and cooling; natural gas or electric storage-type water heaters; natural gas tankless water heaters; electric central air conditioners; refrigerators; freezers; dishwashers; clothes dryers; washing machines; stoves/ranges, cooktops, and wall ovens; gas piping; gas grills; pool heaters and gas fireplaces.** Residential appliances being utilized in a commercial application and all other equipment and/or appliances are excluded from coverage under the Protection Plan for Residential Customers.
- PSE&G warrants that, subject to the terms and conditions stated herein, PSE&G will repair or replace covered residential appliance parts or equipment component parts that become defective or inoperable as a result of normal wear and usage. PSE&G makes no other expressed or implied warranties or guarantees of any kind, and any implied warranties or guarantees are expressly disclaimed.
- PSE&G **WorryFree** Services are only available to customers in PSE&G's service territory. Companies other than PSE&G may provide similar services. A list of those companies may be available from public listings, including telephone directories.
- Protection Plans only cover the specified replacement parts and services associated with the adjustment and repair of covered gas and electric equipment and appliances. Covered services, parts, and labor are provided by PSE&G at no additional cost.
- Residential Protection Plans are optional. In the absence of a Residential Plan, and with your consent, parts will be adjusted, repaired, or replaced for a fee in accordance with PSE&G's pricing and procedures then in effect.
- A Residential Protection Plan applies to one single-family dwelling unit per agreement.
- The Residential Protection Plan shall take effect at 12:00 am on the start date of the Plan. The start date is determined by the end of a mandatory “waiting period” that begins with the date your order is processed by PSE&G. The applicable waiting period varies by the type of appliance Plan purchased and is available on all marketing solicitations as well as the PSE&G website at **pseg.com/terms**. The Plan does not cover parts ordered/or installed during the waiting period.

- PSE&G reserves the right to change the price, scope of coverage, or any terms of the Protection Plan at any time. In the event of such changes, you may discontinue participation in the Protection Plan. Visit [pseg.com/terms](http://pseg.com/terms) for the latest terms and conditions.

## Limitations

- All equipment and parts must be in good working condition on the date the Protection Plan becomes effective. Preexisting defects are not covered. Defective or inoperative appliances and/or equipment are ineligible for coverage. PSE&G assumes no responsibility and shall not be liable for any losses or damages caused by or arising from equipment malfunction, whether covered under the Protection Plan or not. PSE&G shall not be liable for losses or damages of any kind resulting from the failure or inoperability of equipment or systems in excess of the payment received by PSE&G under this agreement.
- All equipment is subject to inspection, at PSE&G's discretion, before acceptance into the Protection Plan.
- All service calls received by PSE&G are handled in order of receipt of request. Within the constraints of weather and workload conditions, PSE&G will endeavor to promptly repair or replace covered parts at no charge. PSE&G will not be responsible for unavailability of parts, labor difficulties, and acts of nature, fires, floods, parts damaged while making access for covered repair or any other conditions beyond the reasonable control of PSE&G.
- All parts replaced under this Program become the exclusive property of PSE&G without rebate or allowance in any form.
- *Multiple Appliances Located in Same Residence* – If there is more than one gas furnace or boiler, electric central air conditioner, or other appliance of the same type in the residence (e.g., two washers or two refrigerators), a Plan must be purchased for each appliance, or service will not be provided. This restriction does not apply to heating or cooling equipment installations by PSE&G for a period of one year from the date of installation.
- *Alternate Heating Systems* – If the heating system is designed by the manufacturer to utilize the domestic water heater to supply heated water to a distribution system, a Premier Boiler Plan must be purchased with a Water Heater Plan, or service will not be provided.
- *Laundry Equipment* – Combination washer/dryer machines, where the washing compartment and drying compartment are separate, require the purchase of a Clothes Washer Plan and a Dryer Plan, or

service will not be provided. Ventless condensing dryers and combination washer/dryers where the washing compartment and drying compartment are the same are excluded from the Program.

- *Central Air Conditioning* – If you do not have an Air Conditioning Plan in force with PSE&G, and a part covered by your Residential Heating Plan fails while in use as part of an electric central air conditioning system, the covered part will be replaced, provided that you agree to pay PSE&G the current air conditioning diagnostic fee.
- PSE&G reserves the right to restrict specific makes and or models of equipment from coverage. In the event that PSE&G does not make the repair, the Company will cancel coverage for this specific appliance and will refund your payments from the effective date of your plan coverage, or date of the last covered repair (whichever is less), for up to 12 months.
- PSE&G has the right to select specific parts to complete the repair. In the event that PSE&G does not make the repair, the Company will cancel coverage for this specific appliance and will refund your payments from the effective date or renewal date of your plan coverage, or date of the last covered repair (whichever is less), for up to 12 months.
- If and when PSE&G determines the repair is not reasonably practical based on the age and condition of the appliance, the Company reserves the right not to repair the equipment. In the event that PSE&G does not make the repair, the Company will cancel coverage for this specific appliance and will refund your payments from the effective date or renewal date of your plan coverage, or date of the last covered repair (whichever is less), for up to 12 months.
- All equipment must be labeled with the manufacturers' model and serial number and conform to the requirements of the American National Standards Institute (ANSI) and be installed in accordance with the installation requirements of the manufacturer, PSE&G, and/or the authority having jurisdiction. The installation and operation of equipment and appliances must conform to all local and state codes and regulations.
- The Plan holder is responsible for providing safe and adequate access to all equipment. Adequate access shall comply with PSE&G "means of access" standards as shown in Chapter 4 of the "General Criteria for Installation of Gas Appliance & Gas Piping" and can be viewed at [pseg.com/GAPmanual](http://pseg.com/GAPmanual). Inaccessible equipment is not eligible for coverage.

- All work must be performed by PSE&G service technicians. There is no reimbursement for covered repairs provided by parties other than PSE&G.
- Participation in the Residential Program may void existing manufacturers' warranties. PSE&G assumes no responsibility for the cancellation of any manufacturer's warranty resulting from your participation in the Residential Program.

### **Program Plan Renewal**

Unless otherwise notified by you, PSE&G shall automatically renew coverage upon expiration of this agreement.

### **Coverage Term**

- The minimum term for Plan coverage is a period of 12 months.
- Payments can be made in one payment or monthly installments.

### **Missed or Late Payments**

- If you do not make your payments as scheduled:
  - PSE&G may suspend and/or cancel your Plan coverage and demand immediate payment of your total balance owed. No repairs will be made until the account is brought up to date.
  - During the period of suspension or cancellation, you may request service outside the terms and conditions of the **WorryFree** Program. Parts will be adjusted, repaired, or replaced for a fee in accordance with PSE&G's pricing and procedures then in effect. Payment for those services may be due upon completion of the service provided.

### **Change of Address**

- Coverage is not transferable to a new address and terminates at your present address when your account is closed. Any balance remaining for unused Plan coverage that was paid in full will be refunded. If you have any past due or current balance owed, that amount will appear on your final bill.
- You may request to continue coverage at your new address. PSE&G **WorryFree** Services are only available to customers who reside in PSE&G's service territory. Companies other than PSE&G may provide similar services. A list of those companies may be available from public listings, including telephone directories.



## WorryFree Plan Cancellations

- PSE&G reserves the right to terminate participation in the WorryFree Program under the following circumstances:
  - Delinquent or non-payment
  - If any of the original manufacturer's parts are no longer available, and if there are no reasonably available alternate or interchangeable parts. PSE&G will not be obligated to retrofit generic parts.
  - If covered equipment does not meet listed Program eligibility requirements.
  - If removing a defective part, or installing a replacement part, could cause a safety hazard or equipment damage.
  - If and when PSE&G determines the repair is not reasonably practical based on the age and condition of the appliance.
  - If the equipment is not used for its usual or designated purposes.
- If your Plan coverage is terminated by PSE&G, the Company will cancel coverage for this specific appliance and will refund your payments from the effective date or renewal date of your Plan coverage, or date of the last covered repair (whichever is less), for up to 12 months.
- If your Plan coverage is canceled for non-payment, you will be responsible for paying the outstanding balance of the full Plan annual price if service was performed during the period.

You have the right to cancel your Residential Protection Plan at any time for any reason. You must notify PSE&G of the cancellation by calling 1-800-350-7734.

- If you cancel within the first 30 days of sign-up or renewal, and if no service has been provided on the covered appliances, you will receive a full refund for payments made on those appliance(s). If you cancel after 30 days of the enrollment or renewal period, you may request a pro-rata refund on the service Plan price for the unexpired term. If a service repair was made, you will be billed for the remaining balance of the 12-month annual Plan price.
- If you cancel a Plan, the coverage may not be reinstated for a period of up to one year from the date of cancellation without PSE&G authorization.

## General Exclusions

- Routine inspections or normal preventive maintenance such as: cleaning and/or replacing air filters; adjusting air registers; cleaning or balancing ductwork; lubricating motors or other moving parts; maintenance cleaning of blower wheels, gauge glasses, and low water cutoffs; except as noted, draining expansion tanks; bleeding air from radiators; purging or topping off hot water heating systems; equipment cleaning; removing dryer lint, and/or any preventive maintenance required by the manufacturer.
- Except otherwise noted, materials and labor for any service in addition to those specified in the Plan, such as sheet metal work, plumbing repairs, leak repairs to house piping, electrical wiring repairs, and equipment relocation.
- Repairs necessary due to negligence, theft, misuse, abuse, vandalism, or lack of normal preventive maintenance.
- Failures caused by fire, freezing, water damage, power supply outages, floods, acts of nature, or any other conditions beyond the reasonable control of PSE&G.
- Repairs necessary due to faulty equipment design, improper installation, or work done by anyone other than PSE&G.
- Commercial applications of all equipment. This includes gas furnaces, boilers, and/or electric central air conditioning units supplying four or more families.
- Gas central heating turn-on from Labor Day through October 31st.
- Installation of new or replacement equipment.
- Appearance and trim parts, finish defects, rusting, corrosion, chipped porcelain and porcelain flaws, exterior housings, or component failure caused by rust or corrosion.
- Parts that are no longer available, and for which no reasonable replacement exists.
- Replacement parts not listed in this booklet.
- Priority service. Our response times vary by seasonal demands and by the nature of the problem. Twenty-four hour response time is not guaranteed.
- Preexisting conditions. Equipment must be in good working condition on the effective date of coverage.
- Reimbursement for work done by others.

**Parts and services not covered may be supplied, repaired, or replaced for a fee in accordance with PSE&G's present procedures. They may also require service from an independent contractor at your expense.**

## HEATING PROTECTION PLANS

### Standard Plan – Residential Natural Gas Furnaces/Boilers used for Central Heating

### Premier Plan – Residential Hot Water Boilers used for Central Heating

Standard Residential Heating Plans cover gas furnaces and boilers with an input rating of less than 400,000 BTUs on the manufacturer's nameplate. (See below for the list of covered parts under the Standard Plan.)

A Premier Residential Heating Plan covers hot water boilers with an input rating of less than 400,000 BTUs on the manufacturer's nameplate and the controls to connected indirect water heater systems. This Plan also covers Tankless Combination Boiler & Water Heating Units. (See below for the extended list of covered parts under the Premier Plan.)

(Also see Types of Heating Unit Exclusions on page 15)

<i>Parts Covered</i>	<i>Standard</i>	<i>Premier</i>
Aquastats	Y	Y
Automatic ignition system components	Y	Y
Belts and pulleys	Y	Y
Blower motors*	Y	Y
Blower wheels (direct drive only)	Y	Y
Burners (main)	Y	Y
Burners (pilot)	Y	Y
Capacitors	Y	Y
Circulator motors, couplers, and motor mounts (no water involved)	Y	Y
Condensate pumps	Y	Y
Conversion burner motors*	Y	Y
ECO safeties	Y	Y
Electric switches	Y	Y
Fan and limit controls	Y	Y
Fusible links	Y	Y
Gas appliance pressure regulators	Y	Y
Gas A valves	Y	Y
Gas B valves	Y	Y
Gas controls	Y	Y
Gauge glasses and associated hardware	Y	Y
Induced draft motor assemblies	Y	Y
Internal wiring	Y	Y
Low water cut-off controls (steam systems only)	Y	Y

<i>Parts Covered</i>	<i>Standard</i>	<i>Premier</i>
Pilot and burner tubing	Y	Y
Pilot generator cartridges	Y	Y
Pilot safeties	Y	Y
Power burner motors*	Y	Y
Pressure relief valves (steam systems only)	Y	Y
Pressure switches	Y	Y
Spill switches	Y	Y
Standard area/room thermostats** (remote temperature sensors are not included)	Y	Y
Steam pressure controls and siphons	Y	
Switching relays	Y	Y
Thermocouples	Y	Y
Thermostat back plates	Y	Y
Thermostat batteries (hard wired only)	Y	Y
Transformers	Y	Y
Vent dampers	Y	Y
Zone valve operators (no water involved)	Y	Y
Air vents		Y
Aquastat wells		Y
Automatic Air Eliminators – all types		Y
Bearing assemblies		Y
Circulator pumps		Y
Drain valves		Y
Draining, refilling, and purging hydronic systems following covered repairs		Y
Expansion tanks		Y
Flow control valves		Y
Low water cutoffs		Y
Pressure reducing valves		Y
Pressure relief valves		Y
Purge air bound distribution loops (excluding individual radiators)		Y
Purge valves		Y
Repair of water leaks to connections of covered parts		Y
Temperature and pressure gauges		Y
Zone valves		Y

- \* If a replacement motor is unavailable, the motor will be rebuilt, if feasible.
- \*\* Defective programmable thermostats will be replaced with comparable models used by PSE&G.

### Steam Boiler

*Shaded areas highlight the location of certain covered parts.*

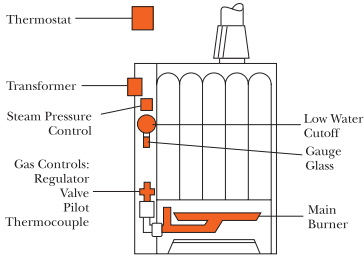

### Hot Water Boiler

*Shaded areas highlight the location of certain covered parts.*

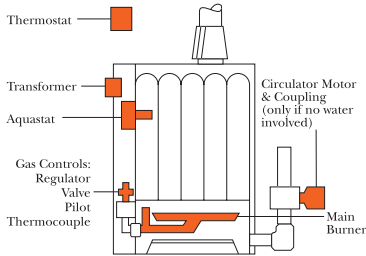

### Premier Gas Hot Water Boiler

*Shaded areas highlight the location of certain covered parts.*

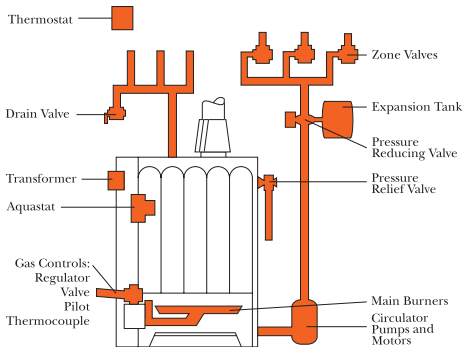

## High Efficiency Furnace

*Shaded areas highlight the location of certain covered parts.*

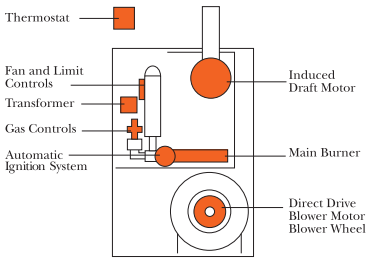

## Warm Air Furnace

*Shaded areas highlight the location of certain covered parts.*

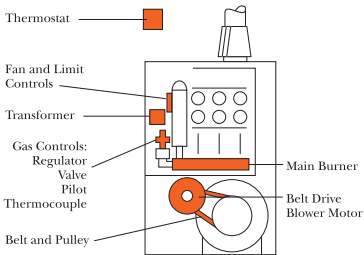

## Conversion Gas Burner

*Shaded areas highlight the location of certain covered parts.*

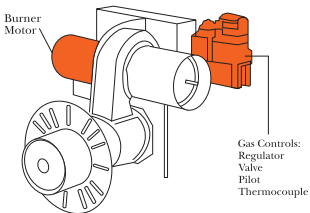

### Parts NOT Covered

- Accessory components, such as humidifiers and electronic air filters
- Automatic water feed valves and controls for steam boilers
- Back flow preventers
- Belt drive blowers
- Blower bearings
- Domestic water supply valves
- Forced air zoning system components (damper assemblies, motors, control panels, etc.)
- Heat exchangers
- Hydronic T&P gauges
- Inaccessible components
- Mixing valve
- Parts for hot water boilers that are in direct contact with water (relief valves, expansion tanks, circulator pumps, pressure reducing valves, etc.) Note that these parts **are** covered under the Premier Hot Water Boiler Plan
- Purging radiators of air
- Radiant heat control valves
- Replacement of indirect hot water storage tanks
- Repair, replacement, or cleaning of domestic hot water coils, mixing valves, shutoff valves, and associated piping
- Repair of water leaks on distribution or radiation piping
- Wireless thermostats, "smart thermostats" with or without Wi-Fi integration, and control systems intended to manage energy use for the entire dwelling
- Vacuum breaker
- Vent pipes
- Water filter housing
- Water filters
- Water leaks, cracks, or rupture of the boiler and/or boiler sections

### Gas Heating System Exclusions:

- Heat pump systems
- Resistive (baseboard) heating and/or space saving heating units of any type

### SEE PAGE 10 FOR OTHER ITEMS NOT COVERED UNDER THE PROGRAM.

*NOTE: If a part covered under your Residential Natural Gas Furnace Plan is replaced while in use as a component of an electric central air conditioner, you will be charged the current diagnostic fee for the air conditioning service call. However, if you have also purchased an Air Conditioning Plan, there will be no diagnostic fee, and covered parts will be replaced in accordance with the terms of your Plan.*

## Residential Natural Gas or Electric Storage-type Water Heaters

### Parts Covered

- Burners (main)
- Burners (pilot)
- ECO safety controls
- Electronic ignition controls
- Exposed internal wiring
- Flame arrestor lint screens (where applicable)
- Gas controls
- Heating elements
- Igniters
- Induced draft motors or assemblies (original equipment only)
- Limit switches
- Pilot and burner tubing
- Pressure switches
- Switching relays
- Temperature and pressure relief valves
- Temperature controls
- Thermocouples
- Thermostats
- Transformers

### Water Heating System

*Shaded areas highlight the location of certain covered parts.*

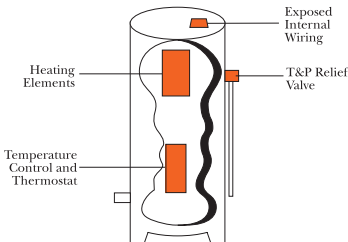
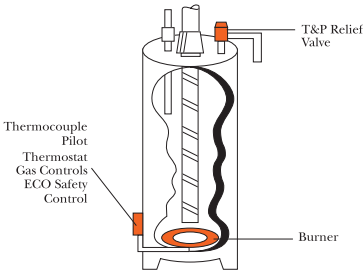



**Water Heating System Exclusions:**

- Heat Pump
- Heat Pump Hybrid Systems
- Indirect Hot Water Heating Systems

***Parts NOT Covered***

- Anodes
- Baffles
- Circulator pumps
- Dip tubes
- Drain valves and shutoff valves
- Equipment damage that results from a flammable vapor incident
- FVIR flame arrestors (single use)
- Flammable vapor ignition resistant system
- Mixing valve
- Vacuum breaker
- Vent pipes
- Water heater tank failure or leakage

**SEE PAGE 10 FOR OTHER ITEMS NOT COVERED UNDER THE PROGRAM.**

## Residential Natural Gas Tankless-type Water Heaters

### Parts Covered

- Air pressure switches
- Automatic flow adjustment valves
- Burners
- Circulation pumps
- Condensate traps
- Controller (PCB) circuit boards
- Gas controls
- Gas pressure switches
- Igniters
- Inducer fans
- Internal GFI switches
- Limit switches
- Transformers
- Water flow sensors
- Water leak detection switches

**Residential Gas Tankless-type Water Heater**  
*Shaded areas highlight the location of certain covered parts.*

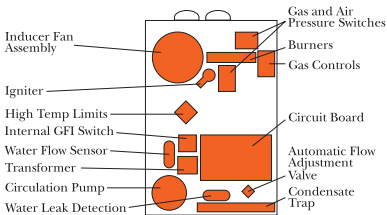

### Parts NOT Covered

- Cleaning or replacements of heat exchangers
- External in-line water filters
- Gas piping
- Mixing valve
- Periodic maintenance
- Removal of scale and lime
- Vacuum breaker
- Venting and air intake piping and associated fittings
- Water leaks
- Water piping and distribution systems

**SEE PAGE 10 FOR OTHER ITEMS NOT COVERED UNDER THE PROGRAM.**

## COOLING PLANS

### Residential Electric Central Air Conditioner Plans

Plans cover electric central air conditioner split systems that utilize R22 or R410A refrigerant, and are rated at five tons (60,000 BTU's) or less by the manufacturer. Air Conditioning systems that share components or controls with a oil-fired furnace are not eligible for coverage.

#### Parts Covered

- Belts
- Blower motors\*
- Blower wheels (direct drive only)
- Capacitors
- Circuit boards
- Cleaning outdoor condenser coils
- Clearing and repairing accessible condensate drain lines
- Condensate pumps
- Condenser fan blades
- Condenser fan motors\*
- Contactors
- External crank case heaters
- Fuses (cartridge type)
- Hard start kits
- High and low pressure switches
- Low ambient temperature controls
- Low voltage wiring (only if wiring is exposed and accessible)
- Motor speed controls
- Relays
- Service port valve caps
- Standard area/room thermostats\*\* (not including sensors)
- Thermostat back plates
- Thermostat batteries (hard wired only)
- Time delay controls
- Transformers
- Valve cores (Schrader type)
- Labor to replace R-22 and R410A is limited to one visit per season\*\*\*

\* If a replacement motor is unavailable, the motor will be rebuilt, if feasible.

\*\* Defective programmable thermostats will be replaced with comparable models used by PSE&G.

\*\*\* Customer responsible for material cost per pound of refrigerant required to make repair.

**NOTE:** Inclement weather, or outside temperatures below 70 degrees Fahrenheit, may postpone the completion of air conditioning repairs.

## Residential Electric Central Air Conditioner

Shaded areas highlight the location of certain covered parts.

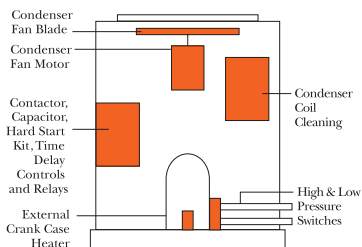

### Parts NOT Covered

- Belt drive blowers and blower bearings
- Cleaning evaporator coils
- Compressors
- Condenser or evaporator coils
- Electric disconnect
- Filter driers
- Forced air zoning system components (damper assemblies, motors, control panels, etc.)
- Heat pump systems or components
- Locating or repairing refrigeration leaks on air conditioning components or line set piping
- Metering systems including TXV valves
- Refrigerant - R22 or R410A\* (material cost)

\* Customer responsible for material cost per pound of refrigerant required to make repair.

**SEE PAGE 10 FOR OTHER ITEMS NOT COVERED UNDER THE PROGRAM.**

# HEAT PUMP SYSTEMS

## Standard Residential Heat Pump

Plan covers Electric Residential Heat Pumps, rated at 5 tons (60,000 BTU's) or less that utilize R22 or R410A refrigerant.

Heat Pumps that utilize a back up system sharing the same ductwork using Oil or Propane are not eligible for coverage.

Heat Pumps used for Geo Thermal installations are not eligible for coverage.

## Standard Residential Heat Pump

*Shaded areas highlight the location of certain covered parts.*

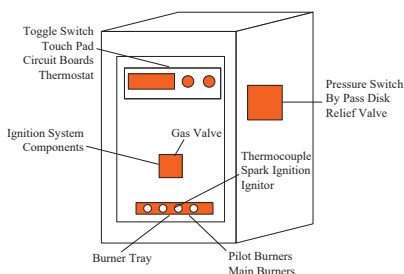

HEAT PUMP

## Parts Covered

- Back up resistance elements
- Belts
- Blower motors
- Direct drive blower wheels
- Capacitors
- Cleaning of condenser fan coil
- Clearing of accessible condensate lines
- Circuit boards
- Condensate pumps
- Condenser fan blades
- Condenser fan motors
- Contactors
- Defrost control boards
- Defrost sensors
- Electronic expansion valve power heads
- External crank case heaters
- Fuses
- Hard start kits
- Low ambient temperature controls
- Motor speed controls
- Potential relays
- Pressure switches
- Relays
- Removable valve cores
- Reversing valve coil only (does not cover entire valve)
- Service port valve caps
- Sequencers
- Thermostat\*
- Thermostat back plate
- Time delay controls
- Transformers
- Labor to replace R-22 or R410A is limited to one visit per year

## *Parts NOT Covered*

- Air filters
- Belt drive blowers & blower bearings
- Cleaning of evaporator coil
- Compressors
- Condenser or evaporator coils
- Electric disconnect
- Filter driers
- Forced air zoning components
- Locating or repairing refrigeration leaks on components or line set piping
- Metering systems including TXV & 4 way valves
- Refrigerant - R22 or R410A\*\* (material cost)
- Wireless thermostats, "smart thermostats" with or without Wi-Fi integration, and control systems intended to manage energy use for the entire dwelling

\* *Defective programmable thermostats will be replaced with comparable models used by PSE&G.*

\*\* *Customer responsible for material cost per pound of refrigerant required to make repair.*

**SEE PAGE 10 FOR OTHER ITEMS NOT COVERED UNDER THE PROGRAM.**

# DUCTLESS HEATING AND COOLING EQUIPMENT

## Ductless Heating and Cooling Systems

Shaded areas highlight the location of certain covered parts.

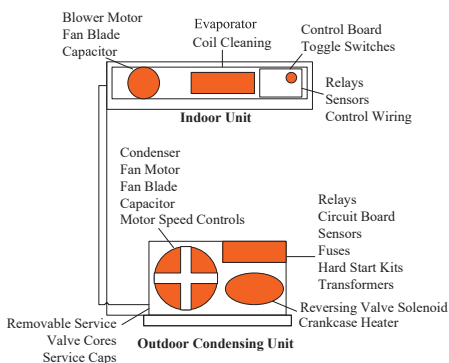

### Parts Covered

- Belts
- Blower motors
- Blower wheels
- Capacitors
- Circuit boards
- Cleaning of condenser fan coil
- Clearing of accessible condensate lines
- Condensate pumps
- Condenser fan blades
- Condenser fan motors
- Contactors
- Defrost control boards
- Defrost sensors
- Electronic expansion valve power head
- External crank case heaters
- Fuses
- Hard start kits
- High & low pressure switches
- Labor to replace R22 or R410A (limited to one time per year)
- Low ambient temperature controls
- Motor speed controls
- Potential relays
- Pressure switches
- Relays
- Removable valve cores
- Reversing valve coil only (does not cover entire valve)
- Service port valve caps
- Thermostat\* Permanently wall mounted only (remotes not covered)
- Thermostat back plate
- Time delay controls
- Transformers
- Thermistor

\* Defective programmable thermostats will be replaced with comparable models used by PSE&G.

### *Parts NOT Covered*

- Air filters
- Branch distribution boxes
- Compressors
- Condenser or evaporator coils
- Electric disconnect
- Filter driers
- Forced air zoning components
- Locating or repairing refrigeration leaks on components or line set piping
- Metering systems including TXV & 4 way valves
- Refrigerant - R22 or R410A\* (material cost)
- Remote control device
- Wireless thermostats, "smart thermostats" with or without Wi-Fi integration, and control systems intended to manage energy use for the entire dwelling

\* *Customer responsible for material cost per pound of refrigerant required to make repair.*

**SEE PAGE 10 FOR OTHER ITEMS NOT COVERED UNDER THE PROGRAM.**



## KITCHEN PLANS

**Important Note:** Kitchen Appliance Plans including Refrigerators, Dishwashers, Stoves/Ranges, Cooktops, and Wall Ovens are grouped in two separate categories. They are:

1. **Standard Brands** – which include all kitchen appliance brands *EXCEPT* the Elite Brands and “built-in” refrigerators.
2. **Elite Brands** – which include “built-in” refrigerators and kitchen appliances which have the following brand name and/or manufacturer: Miele, Gaggenau, Sub-Zero, Wolf, Thermador, Viking, Bosch, Dacor, Fisher & Paykel, Bertazzoni, Jenn-Air, BlueStar, or LaCornue.

*In order to have Plan coverage for an Elite Brand appliance, you must purchase an Elite Brand Protection Plan.*

### Residential Refrigerators

Coverage for Residential refrigerators is limited to “compressor type” refrigerators only. Portable refrigerators and coolers (e.g. wine coolers) are not covered.

#### *Parts Covered*

- Cold controls
- Compressor and related controls
- Condenser and evaporator coils
- Condenser and evaporator motors
- Defrost controls
- Defrost heaters
- Door gaskets
- Door handles
- Door hinges
- Drawer rails and glides
- Door switches
- Exposed internal wiring
- External water or ice maker dispenser components (through the door)
- Fan blades
- Fan switches
- Ice maker controls and knobs
- Ice maker solenoid valves
- Ice makers
- LED lights
- Light bulb sockets
- Power cords
- Refrigerant
- Termination thermostats

## Residential Refrigerator

Shaded areas highlight the location of certain covered parts.

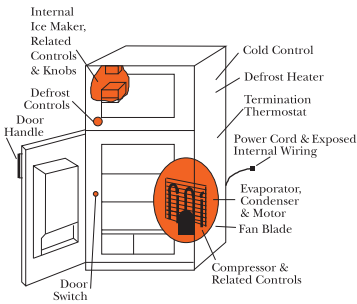

### Parts NOT Covered

- Built in entertainment systems or video display units
- Compartment bins
- Inner door and compartment liners
- Light bulbs
- Remanufactured controls (except authorized manufacturer replacement)
- Sealed refrigeration system repairs (condenser, compressor, evaporator, and associated piping) covered by original manufacturer's warranty
- Shelves/shelf supports
- Water lines inside the door lining
- Water filters
- Water filter housing

**NOTE: PSE&G ASSUMES NO RESPONSIBILITY FOR FOOD SPOILAGE.**

**COMPONENT FAILURE DUE TO RUST OR CORROSION EXCLUDED FROM COVERAGE.**

**SEE PAGE 10 FOR OTHER ITEMS NOT COVERED UNDER THE PROGRAM.**

## Residential Freezers

### Parts Covered

- Capacitors
- Cold controls
- Compressors and related controls
- Condenser and evaporator coils (if accessible)
- Condenser and evaporator motors
- Defrost controls
- Defrost heaters
- Door gaskets
- Door handles
- Door hinges
- Door latches
- Door switches
- Exposed internal wiring
- Fan blades
- Fan switches
- Freezer controls
- LED lights
- Light bulb sockets
- Power cords
- Refrigerant
- Termination thermostats
- Thermostat controls

### Residential Freezer (Stand Alone Type)

Shaded areas highlight the location of certain covered parts.

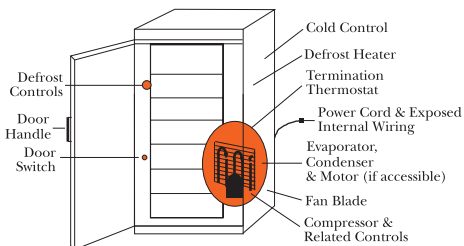

### Parts NOT Covered

- Compartment bins
- Light bulbs
- Remanufactured controls
- Sealed refrigeration system repairs (condenser, evaporator, and associated piping) covered by original manufacturer's warranty
- Shelves/shelf supports

**NOTE: PSE&G ASSUMES NO RESPONSIBILITY FOR FOOD SPOILAGE.**

**COMPONENT FAILURE DUE TO RUST OR CORROSION EXCLUDED FROM COVERAGE.**

**SEE PAGE 10 FOR OTHER ITEMS NOT COVERED UNDER THE PROGRAM.**

## Residential Dishwashers

### Parts Covered

- Conditioner dispensers
- Dish rack adjusters and wheels
- Door hinges
- Door latches
- Door seals
- Door springs and cables
- Door switches
- Fans
- Heating elements
- Internal fill and drain hoses
- Internal wiring
- Limit switches
- Motors
- Pump assemblies
- Selector controls and knobs
- Soap dispenser components
- Solenoid valves
- Spray arms
- Thermostats
- Timers

### Residential Dishwasher

*Shaded areas highlight the location of certain covered parts.*

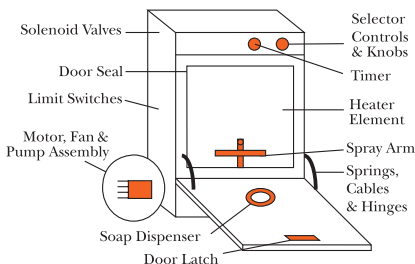

### Parts NOT Covered

- Baskets
- Dish racks
- External fill and drain hoses

**SEE PAGE 10 FOR OTHER ITEMS NOT COVERED UNDER THE PROGRAM.**

**Residential Stoves/Ranges, Cooktops, and Wall Ovens** Appliances that combine microwave cooking with gas or electric cooking in the same compartment or through the same controls are excluded from coverage.

### Parts Covered

- Automatic cooking controls
- Burners and pilots
- Burner valves/control knobs
- Circuit boards
- Clocks/timers (as part of automatic cooking or self-cleaning controls)
- Door gaskets
- Door hinges
- Door locks
- Door springs and cables
- Fans (oven)
- Flame spreaders
- Flame switches
- Gas appliance pressure regulators
- Igniters
- Ignition system components
- Internal tubing
- Internal wiring and fuses
- Micro switches
- Motors
- Oven and broiler elements
- Oven heat controls
- Oven safety valves
- Pilot generators
- Power cords
- Sealed top burners
- Self-cleaning components
- Spark modules
- Surface elements
- Terminal blocks for oven, broiler, and surface elements
- Temperature sensors
- Thermostats

### Electric Stove/Range

*Shaded areas highlight the location of certain covered parts.*

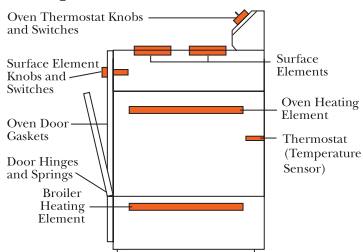

## Gas Stove/Range

*Shaded areas highlight the location of certain covered parts.*

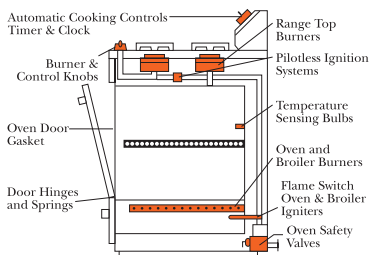

## Gas Cooktop

*Shaded areas highlight the location of certain covered parts.*

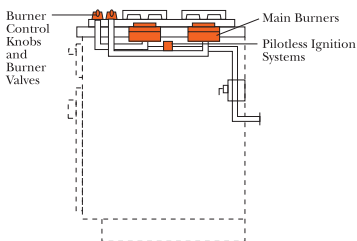

## Electric Cooktop

*Shaded areas highlight the location of certain covered parts.*

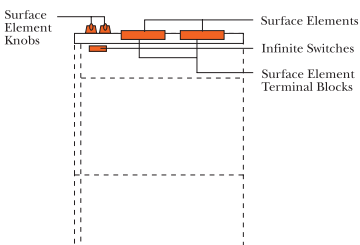

## Electric Wall Oven

*Shaded areas highlight the location of certain covered parts.*

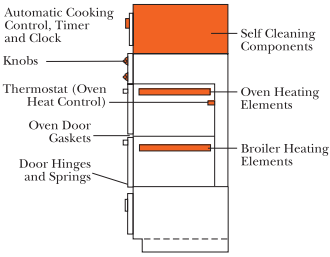

## Gas Wall Oven

*Shaded areas highlight the location of certain covered parts.*

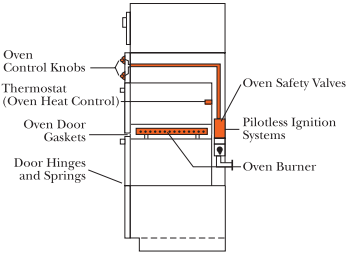

## Parts NOT Covered

- All glass tops, glass door panels, and trim
- Appliance connectors
- Grates, burner caps, drip pans, and oven racks
- Light bulbs, sockets, light switches, and ballasts
- Microwave ovens

**SEE PAGE 10 FOR OTHER ITEMS NOT COVERED UNDER THE PROGRAM.**

## LAUNDRY PLANS

### Residential Clothes Dryers

*For Limitations on types of covered dryers refer to page 6 "Laundry Equipment"*

#### Parts Covered

- Belts
- Blowers
- Burners
- Centrifugal switches
- Control knobs
- Door catches and strikers
- Door clips
- Door gaskets or seals (including those on front loading machines)
- Door springs, hinges, and cables
- Door switches
- Drum bearings
- Drum rollers
- Drum seals
- Electronic controls
- Front drum supports/slides
- Gas valves and valve coils
- Heating elements
- Idler arms
- Igniters
- Ignition system components
- Impellers
- Internal fill and drain hoses
- Internal shutoff valves (original equipment only)
- Internal wiring and fuses
- Limit controls
- Lint screens
- Motors
- Pilots and pilot safeties
- Power cords
- Pulleys
- Sensors
- Start switches
- Steam generating components
- Thermostats
- Timer controls

### Residential Electric Clothes Dryer

*Shaded areas highlight the location of certain covered parts.*

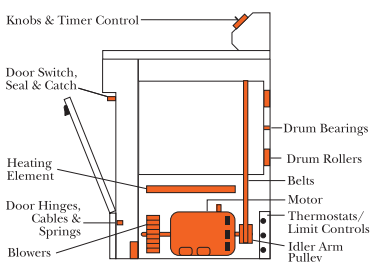



## Residential Gas Clothes Dryer

*Shaded areas highlight the location of certain covered parts.*

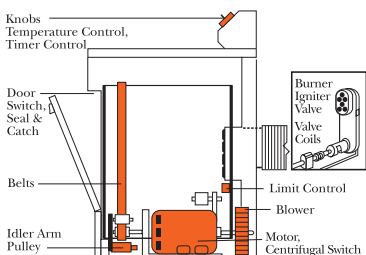

### *Parts NOT Covered*

- Appliance connectors
- Drums
- Light bulbs, sockets, light switches, and ballasts
- Vent connectors

**SEE PAGE 10 FOR OTHER ITEMS NOT COVERED UNDER THE PROGRAM.**

## Residential Washing Machines

*For Limitations on types of covered washing machines refer to page 6 "Laundry Equipment."*

### Parts Covered

- Agitators
- Belts
- Bleach and detergent dispensers
- Bleach and detergent timers
- Circuit board
- Door gaskets, boots, or seals for front loading machines
- Door latches
- Internal fill and drain hoses
- Mode shifter & Transmissions
- Motors, clutches, and couplings
- Operating controls
- Operating knobs and switches
- Power cords and internal wiring
- Pulleys
- Pumps
- Sensors
- Snubber assemblies
- Solenoid valves
- Strut kits
- Timers
- Tub seals and grommets
- Tub suspension components

### Parts NOT Covered

- Basket drives
- Door boots affected by mold or mildew
- External fill and drain hoses
- Tub bearings
- Washer baskets, tubs, and frames

## Residential Washing Machine

*Shaded areas highlight the location of certain covered parts.*

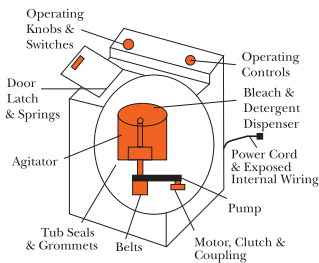

**Front Loading Washing Machine**  
*Shaded areas highlight the location of certain covered parts.*

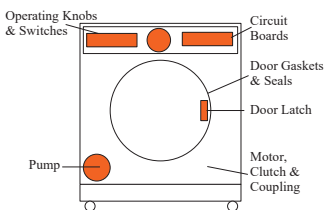

**SEE PAGE 10 FOR OTHER ITEMS NOT COVERED UNDER THE PROGRAM.**

## OTHER HOME PROTECTION PLANS

### Residential Gas Piping Plan

The Residential Gas Piping Plan covers the repair and/or replacement of defective pipefittings, connections, and exposed indoor gas piping (up to 2" in diameter) in accordance with state and local building codes.

#### Parts Covered

- All pipefittings – including unions, couplings, elbows, tees, nipples, caps, and plugs
- Appliance shutoff valves
- Approved appliance connectors and related fittings
- Line valves (up to 2" in diameter)
- Permits (if required)
- Pipe hangers, straps, clamps, etc.
- Steel gas piping (up to 2" in diameter)

Repairs limited to \$2,500 maximum per occurrence.

### Residential Gas Piping

*Shaded areas highlight the location of certain covered parts.*

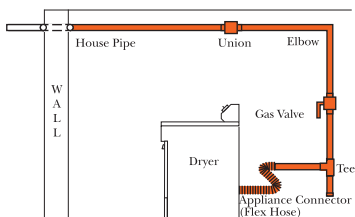

*(See next page for more information.)*

### *Parts NOT Covered*

- Additional piping – or changes to existing pipe size, design, or location – necessitated by equipment installation or failure to meet state or local building codes
- All concealed piping (in walls, ceilings, floors, etc.)
- All corrugated stainless steel tubing (CSST), related fittings, and connections to the steel pipe system
- All underground piping
- Any gas piping located outdoors
- Indoor gas piping that is exposed to water, repeated wettings, or other corrosive materials
- Piping that exceeds 2" in diameter
- Plastic, copper, or aluminum tubing; related fittings; and steel piping connections

**SEE PAGE 10 FOR OTHER ITEMS NOT COVERED UNDER THE PROGRAM.**

## Residential Gas Fireplaces

Includes natural gas: log, built-in, freestanding, and masonry fireplaces.

### Parts Covered

- Automatic gas valves
- Ceramic logs
- Fan motors, blowers, and related controls (if accessible)
- Generator cartridges
- Ignition components
- Internal control wiring and gas tubing
- Log holders
- Main burners
- Pilot burners
- Pilot igniters
- Standard area/room thermostats\*
- Temperature limits and safety controls
- Thermocouples
- Toggle switches
- Transformers

\* Defective programmable thermostats will be replaced with comparable models used by PSE&G.

## Residential Gas Fireplace

Shaded areas highlight the location of certain covered parts.

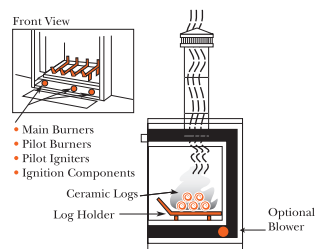

### Parts NOT Covered

- Appliance connectors and house piping
- Burner media (sand, granules, ash, etc.)
- Chimney cleaning
- Cosmetic cleaning or repairs
- Glass fireplace doors, panels, and mesh screens
- Heat exchangers
- Masonry (including fabricated fire brick panels)
- Remote controls (operator or controller)
- Vent components or dampers

**SEE PAGE 10 FOR OTHER ITEMS NOT COVERED UNDER THE PROGRAM.**

## Residential Natural Gas Pool Heater

Coverage is provided for residential natural gas pool heaters with an input rating of up to 425,000 BTU's on the manufacturer's nameplate.

## Residential Natural Gas Pool Heater

*Shaded areas highlight the location of certain covered parts.*

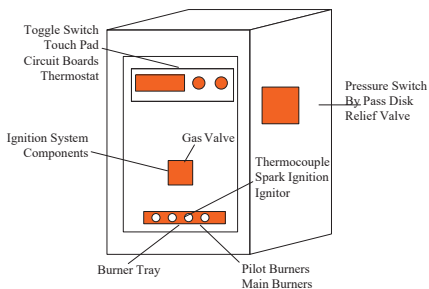

### Parts Covered

- Burner tray
- Cleaning heat Exchanger
- Combustion blower
- Control board
- Gas valve
- Generator cartridge
- Ignition system Components
- Internal wiring
- Limit controls
- Main burners
- Pilot burners
- Pressure switches
- Relief valve
- Roll out switches
- Thermocouple
- Thermostat
- Toggle switch
- Transformer

### Parts NOT Covered

- External piping
- External wiring
- Heat exchanger
- Pool pumps and associated filter equipment
- Timers
- Water leaks

**SEE PAGE 10 FOR OTHER ITEMS NOT COVERED UNDER THE PROGRAM.**

## Residential Natural Gas Grill

The Residential Natural Gas Grill Plan covers outdoor grills operating on natural gas.

### Residential Natural Gas Grill

*Shaded areas highlight the location of certain covered parts.*

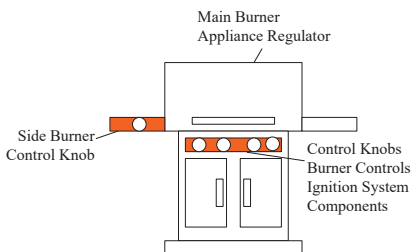

### Parts Covered

- Side burner
- Main burner
- Gas valves
- Ignition system components
- Flame/Heat bars
- Appliance regulator
- Control knobs

### Parts NOT Covered

- Cooking grill
- Coverage on combination units such as those with refrigerators, fryers, etc. are limited to the components of the Natural Gas grill only.
- Gas supply piping to grill
- Infrared burners
- Cosmetic damage
- Corroded or rusted posts, bases, or frame components
- Rotisseries
- Cooking grates
- Lights
- Drip pans
- Shelves
- Handles

*Natural Gas grills only. Propane and Electric grills are not eligible for coverage.*

*Cosmetic damage caused by age, fire, stains, misuse or neglect is not covered.*

*Residential application only.*

**SEE PAGE 10 FOR OTHER ITEMS NOT COVERED UNDER THE PROGRAM.**



## Important Safety Information

Gas emergencies include:

- A strong odor of gas inside or outside your home.
- A gas appliance that will not shut off.
- Suspicion of a carbon monoxide leak.

If you are facing any of these situations, don't wait! Take the following action immediately...

### What to Do During a Gas Emergency

#### **PSE&G Gas Customers:**

- **MOVE** to a safe environment.
- **CALL 911** and PSE&G at **1-800-880-PSEG (7734)** immediately.
- **DO NOT** smoke or operate electrical switches or appliances. Do not operate anything that may produce a spark that might ignite the gas and cause an explosion.
- **DO NOT** assume someone else will report the condition.
- **PROVIDE** the exact location, including cross streets.
- **LET US KNOW** if sewer construction or digging activities are going on in the area.

#### **Non-PSE&G Gas Customers:**

- **MOVE** to a safe environment.
- **CALL** your local gas utility at once to report the gas emergency. Gas emergency services (described above) are provided by your local gas utility without charge.
- **DO NOT** smoke or operate electrical switches or appliances. Do not operate anything that may produce a spark that might ignite the gas and cause an explosion.

Gas appliances should always be operated and maintained according to the manufacturer's instructions. *Always take the time to become familiar with the instructions – especially safety warnings.*

## How to Schedule Repair Service



You can schedule service appointments through **MyAccount** on pseg.com.

You can also call us at **1-800-350-PSEG (7734)**.

Customer Service professionals are always available to take your call. Please be ready to tell the representative:

- Your account number
- What equipment or appliance needs servicing
- What problems you are having
- If applicable, whether the equipment or appliance is gas or electric
- Whether you have a WorryFree Plan on the equipment or appliance to be serviced

The representative will schedule the first available appointment. Response times will vary by seasonal demands and by the nature of the problem.

All service calls are handled in order of receipt of request. Please note that WorryFree Plan customers do not receive priority service.

Costs for repairs are always quoted before the work begins and you can trust PSE&G to show up when we say we will and fix it right, the first time.

# PSE&G WorryFree®

## Replacement Services\*

*When it's **time to replace** your water heater, heating or cooling system you only need to **make one call.***

- No money down and flexible payment options for qualified customers
- Quick and easy scheduling
- Quality equipment and installation

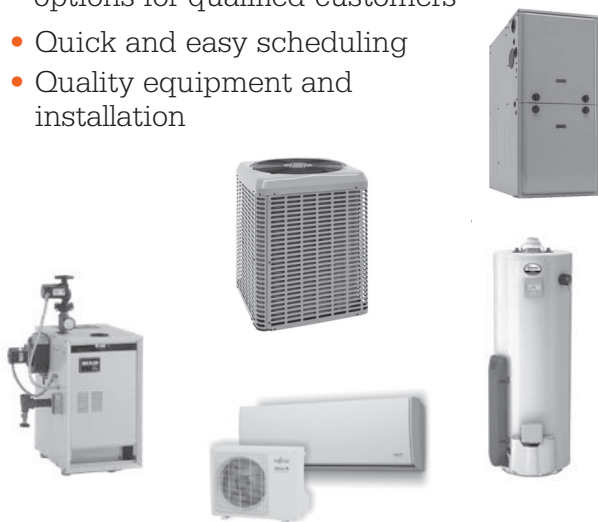

**For information and a  
FREE estimate, call**

# 1.800.539.7734

\* WorryFree optional services are subject to credit approval and are only available to customers in PSE&G's service area. Other providers are available. PSE&G will use an authorized licensed plumber to replace your water heater. Same day installation for water heater is Monday through Saturday, if ordered by 1 p.m.; some exclusions will apply based on model installed. To receive same day installation the replacement unit must be in stock and exchanged for the same equipment. The NJ Board of Public Utilities has not approved the rates offered. PSE&G will provide services, such as gas leak investigations and other safety related services, to our gas customers free of charge. If you detect a gas odor, have a gas appliance that will not shut off, or have a carbon monoxide concern, contact your local gas utility. Customers are not required to purchase WorryFree services to continue to receive safe, adequate, and proper utility service.



**PSEG**

*We make things work for you.*

**Public Service Electric and Gas Company**  
80 Park Plaza, Newark, NJ 07102  
**1-800-350-PSEG (7734) • [pseg.com/worryfree](https://www.pseg.com/worryfree)**