

Operation Manual

***INVERTER-DRIVEN
MULTI-SPLIT SYSTEM
HEAT PUMP
AIR CONDITIONERS***

Type	Model
Wall Mount	TIWM006B22S TIWM008B22S TIWM012B22S TIWM015B22S TIWM018B22S TIWM024B22S TIWM030B22S



IMPORTANT:

***READ AND UNDERSTAND
THIS MANUAL BEFORE
USING THIS HEAT PUMP
AIR CONDITIONER.
KEEP THIS MANUAL FOR
FUTURE REFERENCE.***

P5417089

Important Notice

- Johnson Controls Inc. pursues a policy of continuing improvement in design and performance in its products. As such, Johnson Controls Inc. reserves the right to make changes at any time without prior notice.
- Johnson Controls Inc. cannot anticipate every possible circumstance that might involve a potential hazard.
- This heat pump air conditioning unit is designed for standard air conditioning applications only. Do not use this unit for anything other than the purposes for which it is intended.
- The installer and system specialist shall safeguard against leakage in accordance with local codes. The following standards may be applicable, if local regulations are not available. International Organization for Standardization: (ISO 5149 or European Standard, EN 378). No part of this manual may be reproduced in any way without the expressed written consent of Johnson Controls Inc.
- This heat pump air conditioning unit is operated and serviced in the United States of America and comes with a full complement of the appropriate Safety, Danger, Caution, and Warnings.
- If you have questions, please contact your distributor or contractor.
- This manual provides common descriptions, basic and advanced information to maintain and service this heat pump air conditioning unit that are operable for other models as well.
- This heat pump air conditioning unit is designed for a specific temperature range. For optimum performance and long life, operate this unit within the range limits according to the table below.

Temperature

		Maximum	Minimum
Cooling Operation	Indoor	89°F DB/73°F WB (32°C DB/23°C WB)	69°F DB/59°F WB (21°C DB/15°C WB)
	Outdoor	118°F DB (48°C DB) *	14°F DB (-10°C DB) *
Heating Operation	Indoor	80°F DB (27°C DB)	59°F DB (15°C DB)
	Outdoor	59°F WB (15°C WB) *	-4°F WB (-20°C WB) *

DB: Dry Bulb, WB: Wet Bulb

* The temperature may change depending on the outdoor unit.

- This manual should be considered as a permanent part of the air conditioning equipment and should remain with the air conditioning equipment.

TABLE OF CONTENTS

1. Introduction	1
2. Safety Instructions	1
3. Before Operation.....	5
3.1 Operating Range	5
3.2 Efficient Use of Indoor Unit.....	5
3.3 Efficient Use of Cooling and Heating.....	6
4. Name of Parts and Indications for Safety Consideration	7
4.1 Wall Mount Type.....	7
4.2 Wired Controller (CIW01).....	9
4.3 Wireless Controller (CIR01)	10
5. Operation Method	11
5.1 Wired Controller (CIW01).....	11
5.1.1 Basic Operation	11
5.1.2 Cooling / Heating / Fan Operation	12
5.1.3 Temperature Setting	13
5.1.4 Fan Speed	13
5.1.5 Operation.....	14
5.1.6 Louver Swing Direction.....	15
5.1.7 Comfort Setting.....	17
5.1.8 Automatic Heating/Cooling Operation	18
5.1.9 Setback Operation	18
5.2 Wireless Controller (CIR01)	19
5.2.1 Operation Mode (Cooling, Heating, Dry and Fan Operation)	19
5.2.2 Temperature, Fan Speed and Air Flow Direction Setting.....	21
5.2.3 Automatic Cooling/Heating Mode	22
5.2.4 Timer Setting	24
5.2.5 Louver Swing Direction.....	25
5.2.6 Emergency Operation.....	27
5.2.7 Other Indications.....	28
5.2.8 Identifying Indoor Units Installed Side by Side	29
5.2.9 Handling Wireless Controller	30
6. Automatic Control	31
7. Maintenance	32
7.1 Daily Maintenance.....	32
7.1.1 Cleaning Air Filter	32
7.1.2 Maintenance for Flat Panel.....	34
7.2 Maintenance Prior to and After Use	35
7.3 Replacing Batteries (CIR01).....	35
8. Troubleshooting	36
8.1 This is Not Abnormal	36
8.2 Before Contact	37
8.3 Contact Distributor.....	38
8.4 Alarm Code	39

1. Introduction



Read this manual carefully before working with this product.
Keep this information with the product.

Forward this manual and the warranty registration instructions to the next team of installers and then users. Ask them to keep this manual with the air conditioning unit.

(Refrigerant Piping Work) → (Electrical Wiring Work) → (Ref. Charge Work) → (Test Run) → (User)

- For details on wiring between the indoor unit and the outdoor unit, refer to the installation and maintenance manual for the outdoor unit.
- For details on the optional controller, refer to the installation and maintenance manual for that optional controller module.
- For details on each optional part, refer to the installation and maintenance manual for each optional part.
- For central controller, refer to the installation and maintenance manual for the central controller.

2. Safety Instructions

Signal Words	
 WARNING	Indicates a hazardous situation that, if not avoided, could result in death or serious injury.
 CAUTION	Indicates a hazardous situation that, if not avoided, could result in minor or moderate injury.
NOTICE	Indicates information considered important, but not hazard-related (for example, messages relating to property damage).

General Precautions

 WARNING	To reduce the risk of serious injury or death, read these instructions thoroughly and follow all warnings or cautions included in all manuals that accompanied the product and are attached to the unit. <i>Refer back to these safety instructions as needed.</i>
--	--

- This system should be installed by personnel certified by Johnson Controls, Inc. Personnel must be qualified according to local, state and national building and safety codes and regulations. Incorrect installation could cause leaks, electric shock, fire or explosion. In areas where Seismic Performance requirements are specified, the appropriate measures should be taken during installation to guard against possible damage or injury that might occur in an earthquake. If the unit is not installed correctly, injuries may occur due to a falling unit.
- Use appropriate Personal Protective Equipment (PPE), such as gloves and protective goggles and, where appropriate, have a gas mask nearby. Also use electrical protection equipment and tools suited for electrical operation purposes. Keep a wet cloth and a fire extinguisher nearby during brazing. Use care in handling, rigging, and setting of bulky equipment.
- When transporting, be careful when picking up, moving and mounting these units. Although the unit may be packed using plastic straps, do not use them for transporting the unit from one location to another. Do not stand on or put any material on the unit. Get a partner to help, and bend with your knees when lifting to reduce strain on your back. Sharp edges or thin aluminum fins on the air conditioner can cut fingers, so wear protective gloves.
- Do not touch or adjust any safety devices inside the indoor or outdoor units. All safety features, disengagement, and interlocks must be in place and functioning correctly before the equipment is put into operation. If these devices are improperly adjusted or tampered with in any way, a serious accident can occur. Never bypass or jump-out any safety device or switch.

- Before servicing, turn-OFF the power source and use accepted lockout and tag out procedures at all main switches.
- This unit is pressurized. Never loosen threaded joints while the system is under pressure and never open pressurized system parts.
- Johnson Controls will not assume any liability for injuries or damage caused by not following steps outlined or described in this manual. Unauthorized modifications to Johnson Controls products are prohibited as they...
 - May create hazards that could result in death, serious injury, equipment damage or property damage;
 - Will void product warranties;
 - May invalidate product regulatory certifications;
 - May violate OSHA standards;

! WARNING

- Do not insert fingers or objects into air inlet/outlet. Injury can result from rotating fan blades or energized electrical components.
- Do not touch the wired or wireless controller with wet hands. It can result in failure of the wired or wireless controller or an electrical shock.
- Hair spray, insecticides, lacquers, and other pressurized substances should not be used within 3.3ft (1m) of any air conditioning unit. It can react with energized electrical components and cause fire.
- Do not install the indoor unit anywhere discharge airflow can pass directly toward nearby heating equipment (space heaters). It may interfere with the combustion process in these units.
- Air circulation should be optimized to achieve the best distribution pattern and not settle into isolated pockets that can make people uncomfortable.
- When the indoor unit is operating with heating equipment, ventilate a room sufficiently. Any leaked refrigerant gases that happen to come into contact with any heat source can become toxic on contact and can cause suffocation in the immediate area.
- Shut down at the main power source if the Ground Fault Circuit Interrupter (GFCI) activates frequently. Contact your distributor or contractor immediately. Failure to act accordingly can result in serious injury and damage to the unit.
- If you smell anything burning, shut down the unit and turn OFF the power at the main power source. Contact the fire department and your installer or electrical contractor.
- Make sure that a test for leakage of refrigerant gases is performed. The refrigerant used for this unit (HFC R410A), is a non-flammable, non-toxic, and odorless gas. However if refrigerant should leak and make contact with sparks and fire; then toxic gas is generated. Also, because the fluorocarbon is heavier than air, the floor surface will be filled with it, which can cause suffocation. If fluorocarbon gas should leak, turn OFF all heating equipment and ventilate the room immediately. Mop down or vacuum floor areas of residual toxic particulate.
- Do not operate indoor units with the electrical box and switch panel open and exposed. Incidental contact with energized components can prove fatal.
- When a wireless controller is used, put a distance of at least 3.3ft (1m) between the indoor unit and electric lighting. If not, the receiver part of the unit may be difficult to receive operation commands due to effect of the electric lighting.

Repair / Relocation / Removal

WARNING

- When the air conditioner is to be repaired, transported to a new location or removed, contact your distributor or contractor. Use the specified refrigerant indicated on the labels of outdoor unit. Do not change the unit with anything other. If the repair and the installation are not completed, it may cause electrical shock or fire.

Others

WARNING

- Turn OFF all power at the main power source before performing maintenance work. Failure to do so can result in damage to internal components with severe or fatal electrical shock.
- Insulate all electrical components and connections from exposure to moisture. Failure to do so can result in an electrical short, fire.
- Do not tamper with or attempt to "repair" electrical wiring or connections. Call your installer or electrical contractor. Serious or fatal injury can occur.
- Perform all maintenance work on a firm and stable platform to minimize the risk of injury.
- Do not attempt to "clean" indoor unit components with liquid or powdered cleaning agents during maintenance. Electric shock, sparks, flame, and serious or fatal injury can occur.
- System piping is charged with refrigerant and highly pressurized.

CAUTION

- When the flat panel is opened (closed) or the air filter is attached (removed), hold them firmly. If not, it may cause falling or injury.

About Wireless Controller

- Pay attention to the following to use the batteries correctly. If not, it may cause liquid spill or burst.
 1. Never use new and old batteries together.
 2. Never use the different types of batteries (for example manganese battery and alkaline battery) together.
 3. When the wireless controller is not used over a prolonged period of time (more than 2 or 3 months), remove the batteries from the wireless controller.
- After removing the old batteries, wait 5 or more seconds before inserting the new ones.

3. Before Operation

NOTICE

Power is turned on. Apply power to the outdoor unit(s) at least 12 hours prior to operation of the system for preheating of the compressor oil. Make sure that the outdoor unit is not covered with snow or ice. If it is, remove it by using hot water that is approximately 122°F (50°C). If the water temperature is higher than 122°F (50°C), it will cause damage to plastic parts.

- Turn OFF the main power switch when the system is stopped for a long period of time. If the main switch is not turned OFF, electricity is consumed because the oil heater is always energized during compressor stopping.
- When the system is started after a shutdown longer than approximately 3 months, it is recommended that the system be checked by your service contractor.

3.1 Operating Range

This heat pump air conditioner is designed for the following temperatures. Operate the heat pump air conditioner within this range.

Temperature

		Maximum	Minimum
Cooling Operation	Indoor	89°F DB/73°F WB (32°C DB/23°C WB)	69°F DB/59°F WB (21°C DB/15°C WB)
	Outdoor	118°F DB (48°C DB) *	14°F DB (-10°C DB) *
Heating Operation	Indoor	80°F DB (27°C DB)	59°F DB (15°C DB)
	Outdoor	59°F WB (15°C WB) *	-4°F WB (-20°C WB) *

DB: Dry Bulb, WB: Wet Bulb

* The temperature may change depending on the outdoor unit.

3.2 Efficient Use of Indoor Unit

- **Do not leave a window or a door open.**
The operating efficiency is decreased.
It may cause condensation of the indoor unit. Ventilate a room sufficiently.
- **Attach a curtain or a blind to a window.**
Blocking direct sunlight into a room will increase efficiency.
- **Do not use heat equipment during the cooling operation as much as possible.**
The cooling efficiency is decreased. It may cause condensation and dew drops.
- **Use a circulator if warm air stays around the ceiling.**
Comfort increases. Contact your distributor for details for using a circulator.
- **Turn OFF the main power source if the indoor unit is not to be used for a long period.**
The standby electricity charges will have to be paid even if the indoor unit is unused.

3.3 Efficient Use of Cooling and Heating

COOLING

(1) Airflow Direction

The appropriate air outlet angle is approx. A° as shown in the table. If the cooling is not sufficient, change the airflow direction. Pay attention to condensation, which may occur due to a prolonged cooling operation with low louver angle.

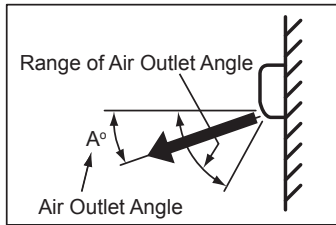

Unit Type	A	Step
TIWM006B22S ~ 012B22S	30	3
TIWM015B22S ~ 030B22S	32	4

(Refer to Sections 5.1.6 and 5.2.5 for details.)

(2) Airflow Volume

“AUTO” is usually used.

HEATING

(1) Airflow Direction

The appropriate air outlet angle is approx. A° as shown in the table. If the heating is not sufficient, change the airflow direction.

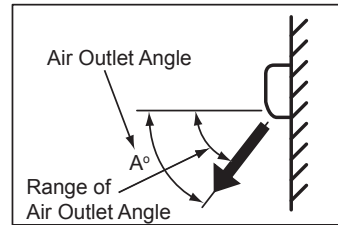

Unit Type	A	Step
TIWM006B22S ~ 012B22S	55	7
TIWM015B22S ~ 030B22S	50	7

(Refer to Sections 5.1.6 and 5.2.5 for details.)

(2) Airflow Volume

“AUTO” is usually used.

NOTE

About Multi-Split System

When the number of indoor unit or the operating mode is changed, the air outlet temperature may be changed and the indoor temperature is changed. In this case, set as follows.

- During Cooling: Lower slightly the temperature setting.
- During Heating: Raise slightly the temperature setting.

4. Name of Parts and Indications for Safety Consideration

Safety labels are affixed to the indoor unit in order to ensure safe use.
Read and understand this manual before using the indoor unit.

4.1 Wall Mount Type

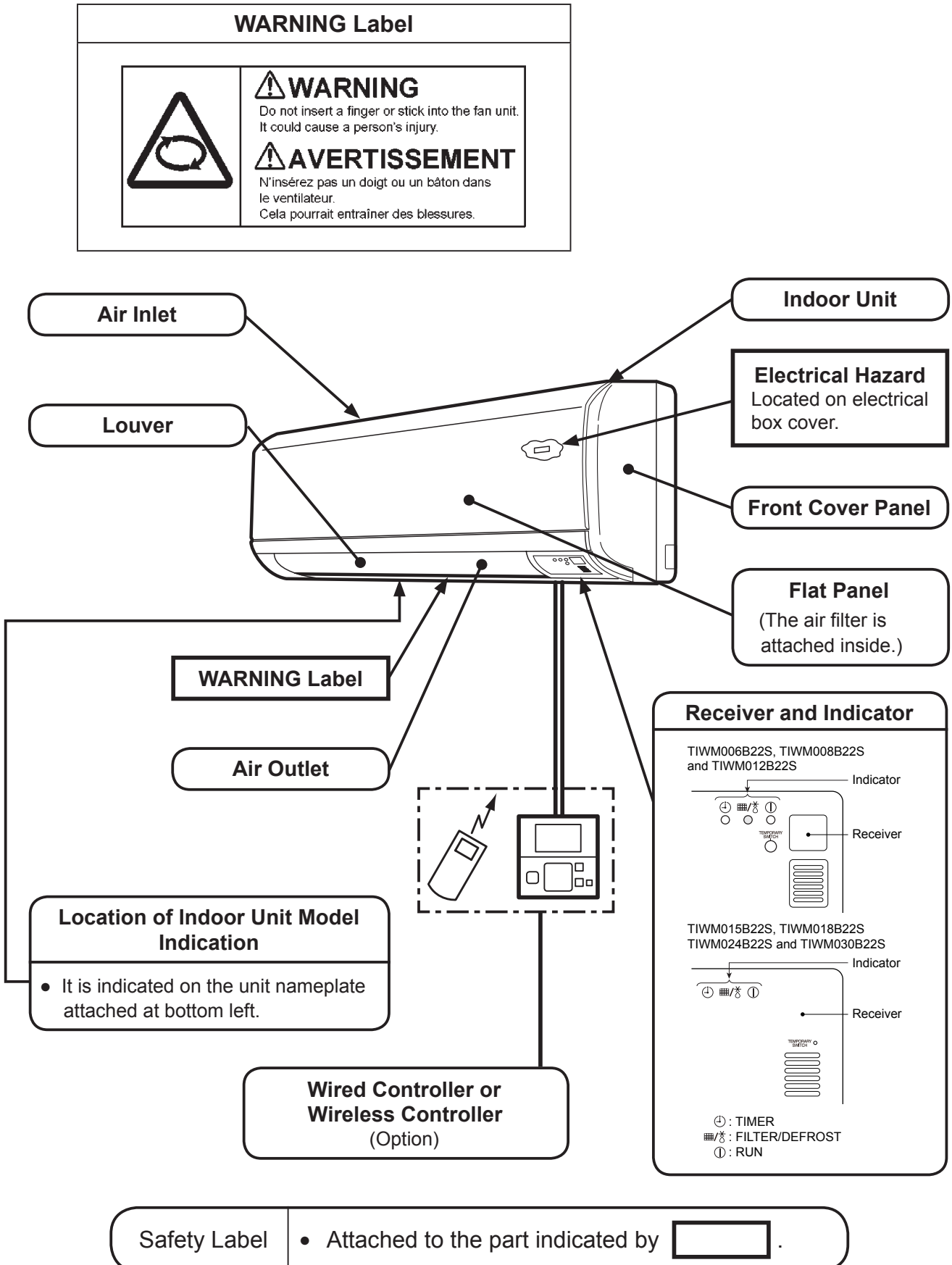

NOTICE

- Wall mount models: either a wired or a wireless controller is available. When a centralized controller is connected, restrictions are in place limiting operation of indoor units with a single wireless controller or using wired and wireless controllers together. Contact your distributor or contractor for details.
 - The indicator “①” of this indoor unit is activated even when the wired controller is used. The indication for timer settings is indicated on the wired controller only.
 - To utilize the wired and wireless controller together, an optional receiver kit is required.
-

4.2 Wired Controller (CIW01)

The following is an example of how the CIW01 is utilized. If other models of the controller are used, operate the unit according to the manual for that controller.

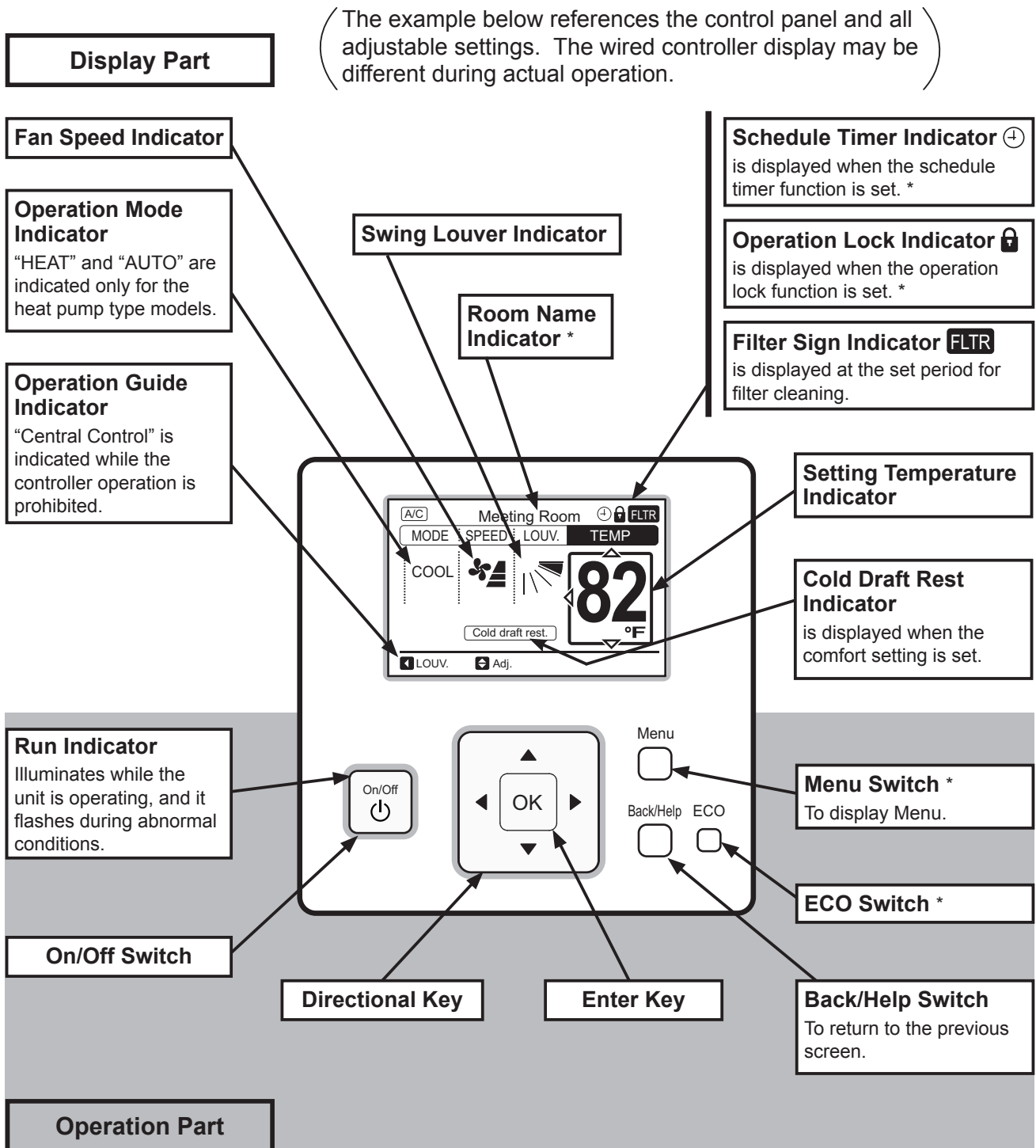

NOTE

* For detailed descriptions, refer to the "Operation Manual" for the wired controller.

4.3 Wireless Controller (CIR01)

- This controller is used to send commands about operation mode timer settings and so on, to the indoor unit. Face the transmitter of the controller toward the receiver of the indoor unit and press the switch to send commands to indoor unit.
- The effective transmission range limit is approximately 19.7ft (6m). The effective distance for transmitting shortens if the transmitter is not perpendicular to the receiver or if there is other electronic interference in the room.
- Use the receiver kit and the indoor unit that are supported by this controller.

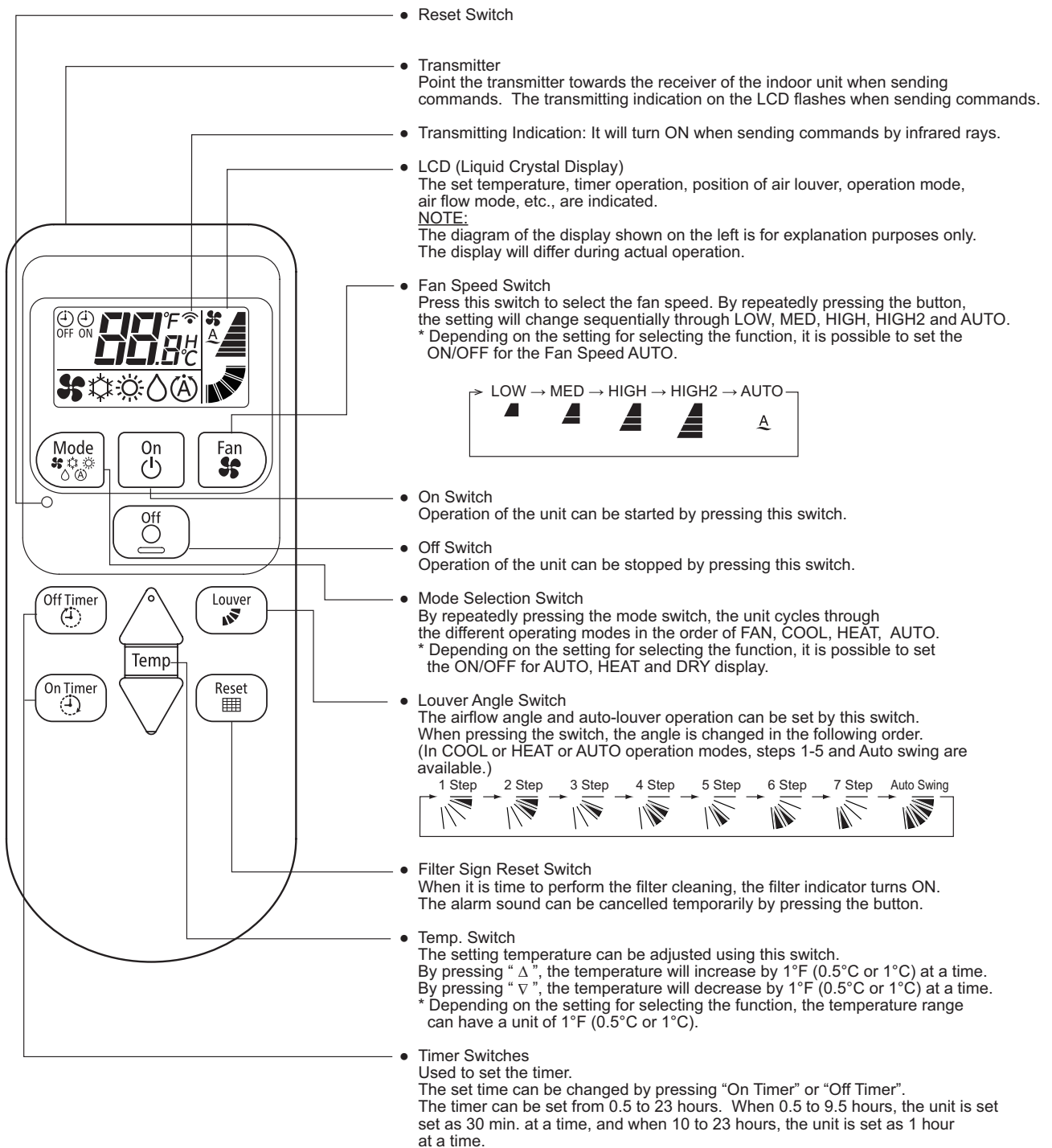

NOTE:



When the wireless controller is prohibited by central controller, this function is disabled even though the indoor unit is set with the wireless controller and the buzzer sounds.

5. Operation Method

5.1 Wired Controller (CIW01)

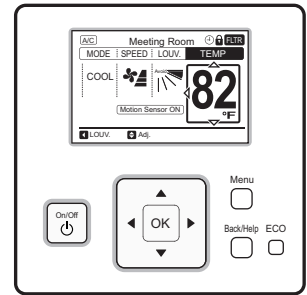
5.1.1 Basic Operation

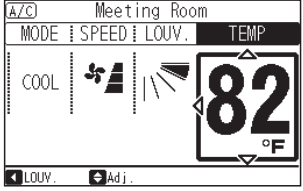

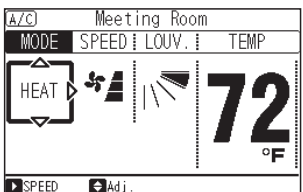
<p>Item Selection</p>	<p>By pressing “◀” or “▶”, the icon “ <p>Menu <input type="checkbox"/> Back/Help <input type="checkbox"/></p> </p>		
<p>Change of Settings</p>	<p>With “MODE”, “SPEED”, “LOUV.” or “TEMP” selected, press “Δ” or “∇”. The setting is changed.</p>	 <p>Menu <input type="checkbox"/> Back/Help <input type="checkbox"/></p>	

5.1.2 Cooling / Heating / Fan Operation

Heating Operation is for VRF systems only and is not available for typical systems.

Function

- * Cooling Operation: To decrease the room temperature.
- * Heating Operation: To increase the room temperature.
- * Dry Operation: To decrease the humidity in the room.
- * Fan Operation: To circulate the air in the room.

- Dry operation may not be performed properly if there are other heat sources that exceed the capacity of the unit.
- In case where the individual setting is operating, decreasing of the humidity during dry operation might be unavailable.

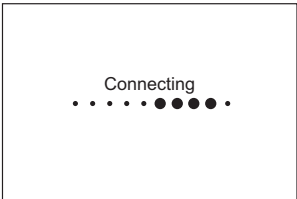
Before Operation	<p>Turn ON the power supply. Turn ON the main power approximately 12 hours before operation in order to preheat the compressor.</p> <p>Do not turn OFF the main power of the indoor unit during heating or cooling season.</p>		
-------------------------	--	--	---

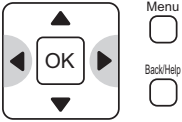
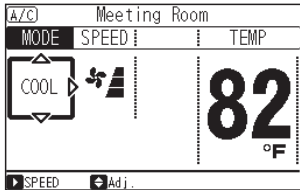
1	Press “◀” or “▶” to select “MODE”.		
----------	------------------------------------	--	---

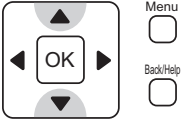
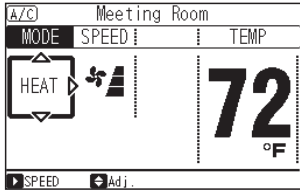
2	<p>By pressing “△” or “▽”, the mode is changed as follows.</p> 		
----------	--	--	---

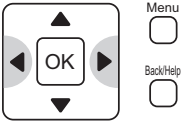
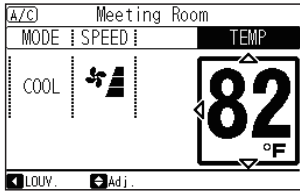
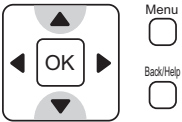
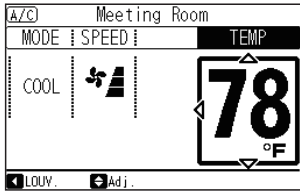

- Automatic cooling/heating operation (AUTO) requires an extra setting. Contact your distributor or contractor for details.

5.1.3 Temperature Setting

<p style="text-align: center; font-size: 24pt; font-weight: bold;">1</p>	<p>Press “◀” or “▶” and select “TEMP”.</p>		
<p style="text-align: center; font-size: 24pt; font-weight: bold;">2</p>	<p>By pressing “Δ”, the temperature is increased by 1°F (0.5°C or 1°C). (Max. 86°F (30°C)) By pressing “∇”, the temperature is decreased by 1°F (0.5°C or 1°C). COOL, FAN operation: Min. 66°F (19°C) HEAT operation: Min. 62°F (17°C)</p>		

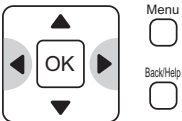
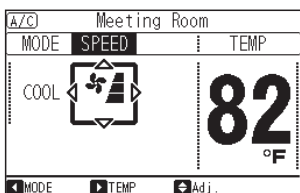

- In case the optional function “Automatic Reset of Setting Temperature” is set: Even if changing the setting temperature on the wired controller, it automatically returns to the temperature set by “Automatic Reset Temperature” after a set time.
- Minimum and maximum temperature setpoint limits can be configured by selecting a cooling lower limit and heating upper limit in the “Function Selection” mode of the wired controller’s Test Run Menu.
- Contact your distributor or contractor for details on optional functions “Automatic Reset of Setting Temperature,” “Cooling Lower Limit for Setting Temperature” and “Heating Upper Limit for Setting Temperature.”

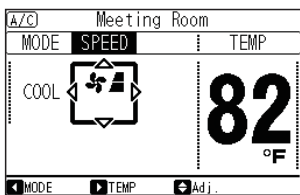
5.1.4 Fan Speed

<p style="text-align: center; font-size: 24pt; font-weight: bold;">1</p>	<p>Press “◀” or “▶” and select “SPEED”.</p>		
<p style="text-align: center; font-size: 24pt; font-weight: bold;">2</p>	<p>By pressing “Δ” or “∇”, the fan speed is changed as follows.</p> 		

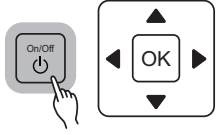
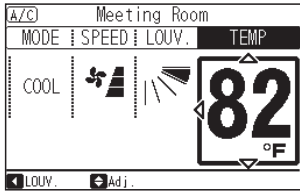

- During the dry operation, the fan speed is automatically changed to “LOW” and cannot be changed to any other fan speed. (“LOW” is NOT displayed on Liquid Crystal Display (LCD) at this time. The present setting condition is displayed on the LCD.)
- The fan speed setting “HIGH 2” may not be available depending on the indoor unit type.

5.1.5 Operation

<p>Operation Start</p>	<p>Press “” (On/Off). The indicator “” is turned ON and the operation is started.</p>		
-------------------------------	---	--	---

Temperature/Air Flow Setting

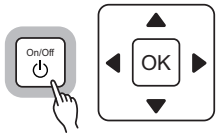
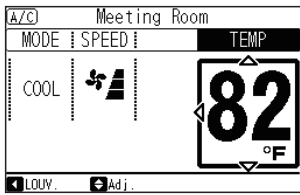

- The setting is stored. Therefore, no daily setting is required. Temperature setpoint and airflow settings are retained after the indoor unit is turned OFF at the controller. In a case where the setting change is required, refer to Sections 5.1.2 to 5.1.4.

<p>Operation Stop</p>	<p>Press “” (On/Off) again. The indicator “” is turned OFF and the operation will stop.</p>		
------------------------------	---	--	---

- The indoor unit fan may continue to operate for up to 2 minutes following the heating cycle to dissipate residual heat from the indoor unit.



5.1.6 Louver Swing Direction

1

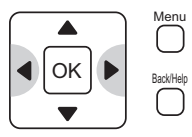
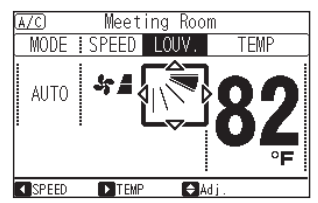
Press “” (On/Off).
Make sure that the operation is started.
Press “” or “” and select “LOUV.”.



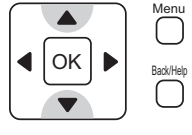
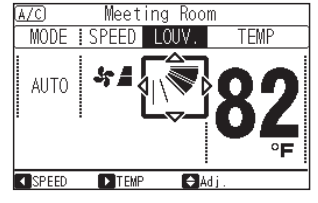

2

By pressing “” or “”, the louver direction is changed as follows.



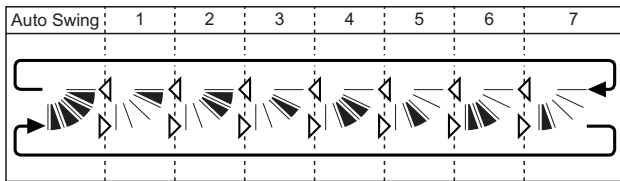







LCD Indication









 : Auto-swing operation is started. At this time, the louver icon swings repeatedly on LCD.

TIWM006B22S ~ TIWM012B22S

Step	1	2	3	4	5	6	7	-
LCD Indication								
Air Outlet Angle	Approx. 15°	Approx. 22°	Approx. 28°	Approx. 35°	Approx. 42°	Approx. 48°	Approx. 55°	
FAN			Recommended Angle	Angle Range				
				Auto-Swing Range				
Air Outlet Angle	Approx. 15°	Approx. 23°	Approx. 30°	Approx. 38°	Approx. 45°			
COOL and DRY			Recommended Angle	Angle Range				
				Auto-Swing Range				
Air Outlet Angle	Approx. 25°	Approx. 30°	Approx. 35°	Approx. 40°	Approx. 45°	Approx. 50°	Approx. 55°	
HEAT			Angle Range				Recommended Angle	
			Auto-Swing Range					

TIWM015B22S ~ TIWM030B22S

Step	1	2	3	4	5	6	7	-
LCD Indication								
Air Outlet Angle	Approx. 10°	Approx. 17°	Approx. 23°	Approx. 30°	Approx. 37°	Approx. 44°	Approx. 50°	
FAN			Recommended Angle	Angle Range				
				Auto-Swing Range				
Air Outlet Angle	Approx. 10°	Approx. 17°	Approx. 25°	Approx. 32°	Approx. 40°			
COOL and DRY			Recommended Angle	Angle Range				
				Auto-Swing Range				
Air Outlet Angle	Approx. 10°	Approx. 17°	Approx. 23°	Approx. 30°	Approx. 37°	Approx. 44°	Approx. 50°	
HEAT			Angle Range				Recommended Angle	
			Auto-Swing Range					

NOTE:
When step 6 or step 7 is selected during cooling operation and dry operation, the louver angle is fixed at step 5.

- The louver angle indicated on the LCD and the actual louver angle do not correspond precisely with each other during the auto-swing mode operation. When the louver is fixed, set the louver angle according to the louver position indicated on the LCD.
- The louver may NOT stop immediately after the switch is pressed.
- For adjustment of vertical blade, refer to next page.

- Adjusting Vertical Blade
Adjust the vertical blade by hand as shown below.

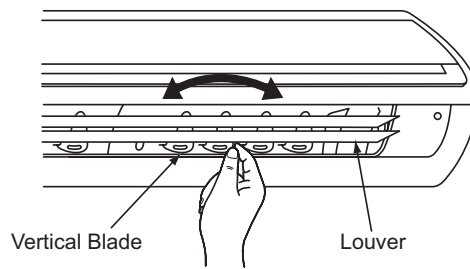

- Automatic Louver Setting
The swing louver is stopped and moved by controlling the wired controller.
The louver automatically closes when the unit is stopped from the wired controller.

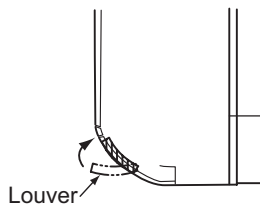

TIWM006B22S ~ TIWM012B22S

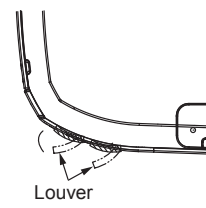

TIWM015B22S ~ TIWM030B22S

- Louver Angle during Cooling and Dry Operation
The louver angle self-adjusts from its default setting during times of cooling and dry conditions to prevent condensation buildup. Louver angle changes are not shown on the LCD of wired controller.
- Louver Angle during Heating Operation
The louver angle self-adjusts for heating conditions.

- * When the heating operation starts
 - * When the defrost operation starts
- ➡ The louver is at a 15-degree angle.

Above louver angle changes are not shown on the LCD of the wired controller.

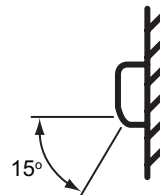

➡ When the discharge temperature is higher than 86°F (30°C), the louver angle automatically returns to the setting on the wired controller.

NOTICE

Do not attempt to move the louver by hand as this will damage the automatic louver setting function.

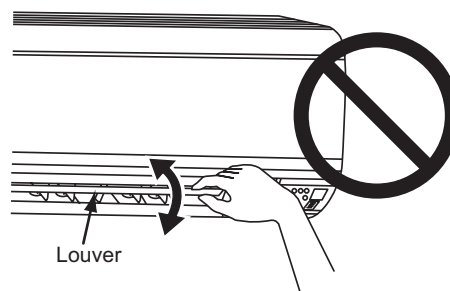

5.1.7 Comfort Setting

This function is used to control cooling of the discharged air when in the cooling mode.

NOTE

- The cool air level order is as follows:
“HIGH” > “MED” > “LOW” and the temperature of the discharged air is high.
- It is possible the operation may not function if there are more than two units operating.
- When this function is set, it may take time for the entire room to cool down.

1	<p>Select “Comfort Setting” from the “Menu” and press “OK”. The “Comfort Setting” screen is displayed.</p>	
2	<p>By pressing “◀” or “▶” the Comfort Setting Mode changes as follows : OFF ↔ LOW ↔ MED ↔ HIGH</p> <p>Select the “Control Cool Air” level and press “OK”.</p>	
3	<p>The setting confirmation screen is displayed. Select “Yes” with “◀” or “▶” and press “OK” to confirm the setting. The screen returns to normal mode.</p>	

An automatic heating/cooling operation and setback operation requires extra settings.
Contact your distributor or contractor for details.

5.1.8 Automatic Heating/Cooling Operation

In case dual setpoint is selected in automatic heating/cooling operation, during auto mode both cooling setpoint and heating setpoint can be selected.

By default, temperature when the heating/cooling mode changes are as follows.

Cooling mode changes to heating mode when the indoor temperature reaches the heating setpoint -2°F (-1°C).

Heating mode changes to cooling mode when the indoor temperature reaches the cooling setpoint +2°F (+1°C).

If you need to change the setpoint for changing modes, contact your distributor or contractor for details.

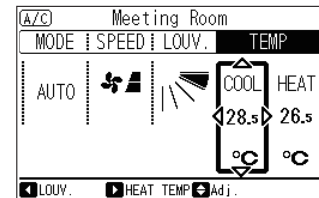

NOTE:

In case of Celsius Indication.

5.1.9 Setback Operation

If the setback operation is enabled and the card key is removed, the louver starts to open in approximately 5 seconds, the setpoint is adjusted for setback, and the fan operates at “Low” speed. During this time, “Setback” is displayed on the LCD.

By default,

Cooling: Setpoint +4°F (+2.5°C)

Heating: Setpoint -4°F (-2.5°C)

If the adjustment for setback operation must be changed, contact your distributor or contractor for details.

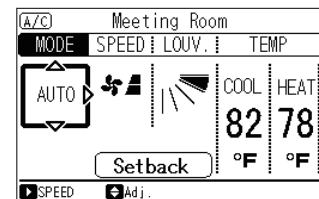

NOTE:

In case of Fahrenheit Indication.

5.2 Wireless Controller (CIR01)

5.2.1 Operation Mode (Cooling, Heating, Dry and Fan Operation)

When VRF system is used with wireless controllers, follow the procedure as shown below.

Function

- * Cooling Mode (COOL): To decrease the room temperature.
- * Heating Mode (HEAT): To increase the room temperature.
- * Dry Mode (DRY): To decrease the humidity in the room.
- * Fan Mode (FAN): To circulate the air in the room.

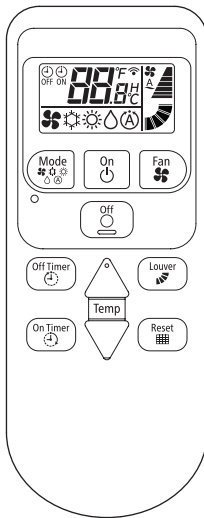

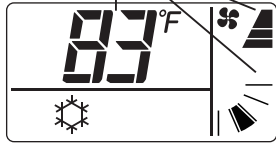



<h3>Before Operation</h3>	<p>Turn ON the power supply. Apply power to unit(s) for approximately 12 hours before operation in order to preheat the compressor.</p> <p>Do not turn OFF the main power of the indoor unit during season of heating or cooling.</p>	
<p style="text-align: center; font-size: 2em;">1</p>	<p>Press "Mode" switch. By repeatedly pressing "Mode" switch, the operation mode switches in the order of FAN , COOL , HEAT , DRY and AUTO .</p>	<p>LCD indications of setting temperature, fan speed and airflow angle are turned ON.</p>  <p>Above indication is for cooling operation.</p> <p>When the unit operation is stopped, LCD indications of setting temperature, fan speed and air flow angle are turned OFF after 10 seconds without pressing the switches.</p>

- Refer to Section 5.2.3 "Automatic Cooling/Heating Mode" for automatic cooling/heating operation mode.

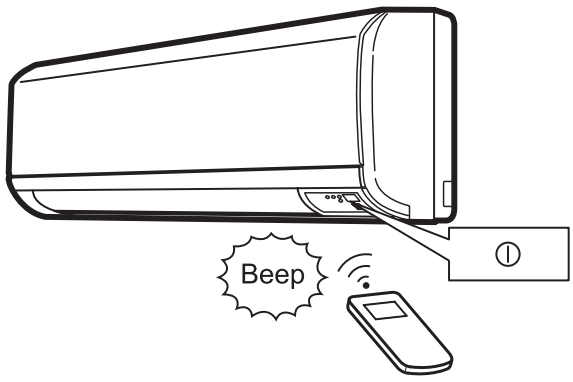

NOTE

The indoor unit emits a beeping sound when the wireless controller is activated.

2	<p>Point the transmitter towards the receiver and press “On ” switch.</p> <p>When the transmitting indicator “” flashes on the LCD of wireless controller, the indicator “” (orange) on indoor unit is turned ON and the beeping sound is heard. The operation is started.</p> <p>NOTE: Do not press “On ” and “Off ” switches repeatedly (within 3 seconds). If the switch is pressed frequently, the controller may not work correctly.</p>	
----------	---	--

Temperature, Fan Speed and Airflow Direction Setting

- The setting condition is stored. Therefore, no daily setting is required. Temperature setpoint and airflow settings are retained after the indoor unit is turned OFF at the controller. In a case where the setting change is required, refer to Section 5.2.2.

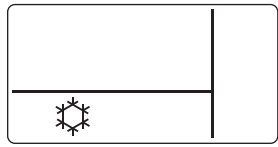
Stop	<p>Point the transmitter towards the receiver and press “Off ” switch.</p> <p>The indicator “” (orange) on indoor unit is turned OFF and the beeping sound is heard. The indications of setting temperature, fan speed, and airflow angle are turned OFF. The operation is stopped.</p>	 <p>The indications of setting temperature, fan speed and airflow angle are turned OFF.</p>
-------------	---	--

- The indoor unit fan may continue to operate for up to 2 minutes following the heating cycle to dissipate residual heat from the indoor unit.



5.2.2 Temperature, Fan Speed and Air Flow Direction Setting

NOTE

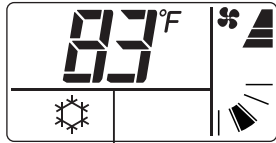

When the wireless controller is pressed, the transmitting indicator “” flashes on the LCD display of the wireless controller and the beeping sound is heard from the indoor unit.

<p>Temperature</p>	<p>Point the transmitter towards the receiver and press “Temp” switch to set the temperature. By pressing “Δ”, the temperature is increased by 1°F (0.5°C). By pressing “∇”, the temperature is decreased by 1°F (0.5°C).</p>	 <p>The set temperature is set to 83°F (28°C) in the cooling operation.</p>
---------------------------	---	--

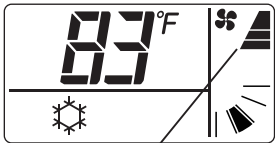
- The available set temperature range is 66°F (19°C) to 86°F (30°C) during cooling, dry or fan operation.

<p>Fan Speed</p>	<p>Point the transmitter towards the receiver and press “Fan ” switch to set the fan speed. By repeatedly pressing the switch, the setting changes sequentially as shown below. “MED” is normally used.</p> <p>→ LOW → MED → HIGH → HIGH2 → AUTO</p> 	 <p>The fan speed is set to “HIGH” in the cooling operation.</p>
-------------------------	---	--

- The fan speed can be set for each operating mode except Dry mode, which forces fan operation at “LOW” speed only.

<p>Air Flow Direction</p>	<p>Point the transmitter towards the receiver and press “Louver ” switch to set the louver angle. By pressing “Louver ” switch, the louver angle is changed as follows.</p> <p><u>LCD Indication</u></p>  <p>NOTE: Auto-swing and 1 step to 5 step louver settings are only available for the cooling and dry modes.</p>
----------------------------------	---

- Louver settings are automatically changed during heating, cooling, or dry operation.

5.2.3 Automatic Cooling/Heating Mode

Automatic Cooling/Heating Mode is for Heat Recovery VRF system only and is not available for other systems. Also note that there is quite a temperature difference between cooling and heating operation when using this function.

The automatic cooling/heating operation is set by the function selection. Contact your distributor and contractor for details.

Function

Automatic Cooling/Heating Mode automatically switches cooling and heating based on the set temperature.

The cooling operation is performed when the inlet air temperature is approximately 3.6°F (2°C) higher than the set temperature.

The heating operation is performed when the inlet air temperature is approximately 3.6°F (2°C) lower than the set temperature.

NOTE

- If the fan speed is set to “LOW” during the heating operation, the operation tends to be stopped by activation of the protection devices, etc. In this case, set the fan speed to “MED”, “HIGH” or “HIGH 2”.
- The heating operation is not available when the outdoor temperature is higher than approximately 70°F (21°C).

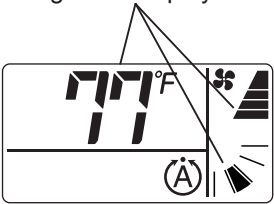
<p>Before Operation</p>	<p>Turn ON the power supply. Apply power to unit(s) for approximately 12 hours before operation in order to preheat the compressor.</p> <p>Do not turn OFF the main power of the indoor unit during season of heating or cooling.</p>	
<p>1</p>	<p>Press and hold “Mode” switch for more than 3 seconds. The indication “Ⓐ” (automatic cooling/heating operation) is displayed.</p> <p>When “Mode” switch is pressed at “Ⓐ”, the fan operation is started.</p>	<p>Indicators for temperature setting, fans speed, and airflow angle are displayed.</p>  <p>Displayed settings remain illuminated for 10 seconds after the unit operation is stopped before going dark.</p>

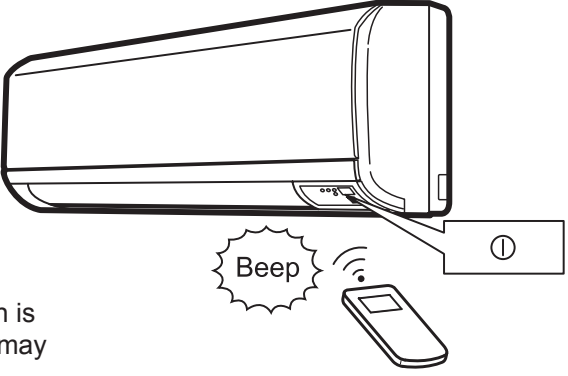
2	<p>Point the transmitter portion of wireless controller towards the receiver and press “On ⏻” switch.</p> <p>When the transmitting indicator “📶” flashes, the indicator “Ⓜ” (orange) on indoor unit is turned ON and the beep sound is heard. The operation is started.</p> <p><u>NOTE:</u> Do not press “On ⏻” and “Off ⏻” switches repeatedly (within 3 seconds). If the switch is pressed frequently, the wireless controller may not work correctly.</p>	
----------	--	--

Temperature, Fan Speed and Airflow Direction Setting

- To set the temperature, fan speed and airflow direction, refer to Section 5.2.2 “Temperature, Fan Speed and Airflow Direction Setting”.

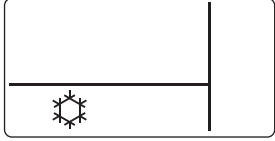
Stop	<p>Point the transmitter towards the receiver and press “Off ⏻” switch.</p> <p>The indicator “Ⓜ” (orange) on the indoor unit is turned OFF and the beep sound is heard. The indications of setting temperature, fan speed, and airflow angle are turned OFF. The operation is stopped.</p>	 <p>The indications of setting temperature, fan speed, and airflow angle are turned OFF.</p>
-------------	--	---

- The indoor unit fan may continue to operate for up to 2 minutes following the heating cycle to dissipate residual heat from the indoor unit.

5.2.4 Timer Setting

Function

- This function is used to start or stop unit operation at a pre-set time.
- The timer setting is available for ON TIME and OFF TIME.
 On Timer ☺: The operation is started beyond the set time.
 Off Timer ☺: The operation is stopped beyond the set time.

<p style="text-align: center; font-size: 24pt;">1</p>	<p>Press “On Timer ☺” or “Off Timer ☺” switch. By repeatedly pressing “On Timer ☺” or “Off Timer ☺”, the indication of setting time is changed. When the transmitting indicator “📶” flashes, the indicator “☺” (green) of indoor units is turned ON and a beeping sound is heard. Timer setup is complete.</p> <p>Timer setup functions can be set at half hour intervals up to 10 hours and at one-hour intervals up to 23 hours after 10 hours.</p>	<p style="text-align: right;">Transmitting Indication</p>  <p>The setting time for “ON TIMER” is set to 6 hours.</p>
--	---	---

<p>Cancellation</p>	<p>Point the transmitter portion of wireless controller towards the receiver and press “On Timer ☺” or “Off Timer ☺” switch. By repeatedly pressing “On Timer ☺” or “Off Timer ☺”, the indication of setting time is changed.</p> <p>When 23 hours is displayed and “On Timer ☺” or “Off Timer ☺” switch is pressed, the display disappears.</p> <p>Then the transmitting indicator “📶” flashes, the indicator “☺” (green) of indoor unit is turned OFF and the beeping sound is heard. Timer setup is deactivated.</p>
----------------------------	---

5.2.5 Louver Swing Direction

Function

- This function is used to change the louver angle to the required angle.
- Fixed:
The louver can be set at the required angle.
- Auto-swing:
The louvers can be set to continuously oscillate.

NOTE

- When the wireless controllers are pressed, the transmitting indicator “” flashes on the LCD of wireless controller and a beeping sound is heard from the indoor unit.

1

Point the transmitter towards the receiver and press “LOUVER” switch to set the louver angle.
By pressing “LOUVER” switch, the louver angle is changed as follows.

LCD Indication

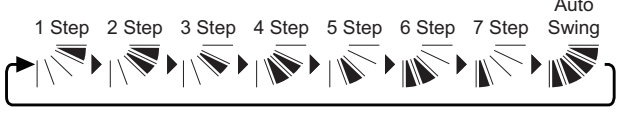

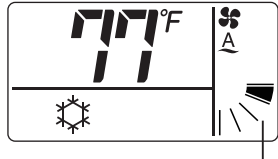

The louver angle is set to 1 step at “AUTO” in the cooling mode.

2

By pressing the “LOUVER” switch, the louver direction is changed as follows.

TIWM006B22S to TIWM012B22S

Step	1	2	3	4	5	6	7	-
LCD Indication								
Air Outlet Angle	Approx. 15°	Approx. 22°	Approx. 28°	Approx. 35°	Approx. 42°	Approx. 48°	Approx. 55°	
FAN			Recommended Angle	Angle Range				Auto Swing
				Auto-Swing Range				
Air Outlet Angle	Approx. 15°	Approx. 23°	Approx. 30°	Approx. 38°	Approx. 45°			
COOL and DRY			Recommended Angle	Angle Range				
				Auto-Swing Range				
Air Outlet Angle	Approx. 25°	Approx. 30°	Approx. 35°	Approx. 40°	Approx. 45°	Approx. 50°	Approx. 55°	
HEAT				Angle Range				Recommended Angle
				Auto-Swing Range				

TIWM015B22S to TIWM030B22S

Step	1	2	3	4	5	6	7	-
LCD Indication								
Air Outlet Angle	Approx. 10°	Approx. 17°	Approx. 23°	Approx. 30°	Approx. 37°	Approx. 44°	Approx. 50°	
FAN			Recommended Angle	Angle Range				Auto Swing
				Auto-Swing Range				
Air Outlet Angle	Approx. 10°	Approx. 17°	Approx. 25°	Approx. 32°	Approx. 40°			
COOL and DRY			Recommended Angle	Angle Range				
				Auto-Swing Range				
Air Outlet Angle	Approx. 10°	Approx. 17°	Approx. 23°	Approx. 30°	Approx. 37°	Approx. 44°	Approx. 50°	
HEAT				Angle Range				Recommended Angle
				Auto-Swing Range				

NOTE:
The louver settings are only available from 1 through 5 steps and auto swing is only available in the cooling and dry modes. (Steps 6 and 7 are unavailable.)

- The louver angle indicated on the LCD and the actual louver angle do not correspond precisely with each other during the auto-swing mode operation. Individual angled-louver settings are displayed on the LCD display.
- The louver may NOT stop immediately after the switch is pressed.
- For adjustment of vertical blade, refer to next page.

- **Adjusting Vertical Blade**
Adjust the vertical blade by hand as shown below.

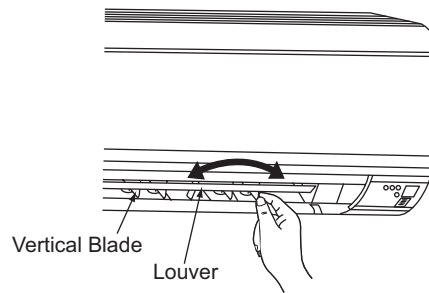

- **Automatic Louver Setting**
The swing louver is stopped and moved by controlling the wireless controller.
The louver automatically closes when the unit is stopped from the wireless controller.

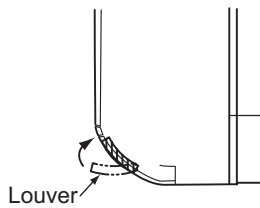

TIWM006B22S ~ TIWM012B22S

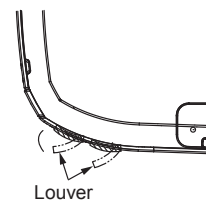

TIWM015B22S ~ TIWM030B22S

- **Louver Angle during Cooling and Dry Operation**
The louver angle self-adjusts from its default setting during times of cooling and dry conditions to prevent condensation buildup. Louver angle changes are not shown on the LCD of wireless controller.
- **Louver Angle during Heating Operation**
The louver angle self-adjusts for the heating conditions.

- * When the heating operation starts
 - * When the defrost operation starts
- ➡ The louver is at a 15-degree angle.

Above louver angle changes are not shown on the LCD of the wireless controller.

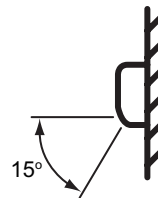

➡ When the discharge temperature is higher than 86°F (30°C), the louver angle automatically returns to the setting on the wired controller.

NOTICE

Do not attempt to move the louver by hand as this will damage the automatic louver setting function.

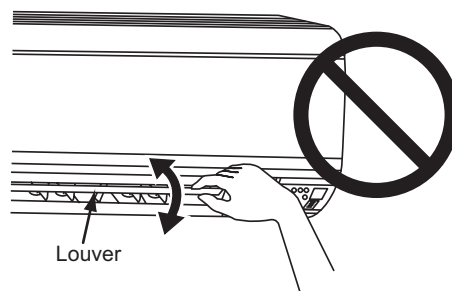

5.2.6 Emergency Operation

Function

When the wireless controller battery power dies, but the operation is required, the temporary switch on the unit is used.

NOTE

The operation is as follows.

Automatic Cooling/Heating Operation

Setpoint Temperature: 77°F (25°C)

Fan Speed: HIGH

Louver Angle: Horizontal

TIWM006B22S ~ TIWM012B22S

Press the temporary switch.

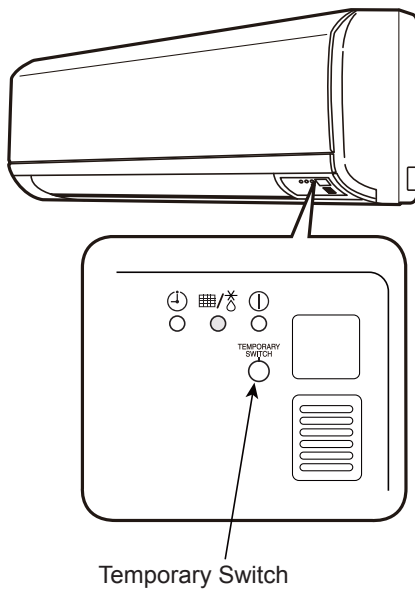

TIWM015B22S ~ TIWM030B22S

Press the temporary switch with a non-metallic tool, etc.

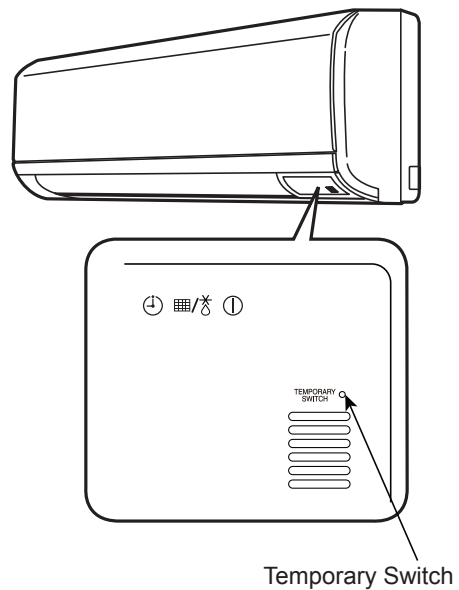







The emergency operation is stopped when the temporary switch is pressed again.

NOTE:

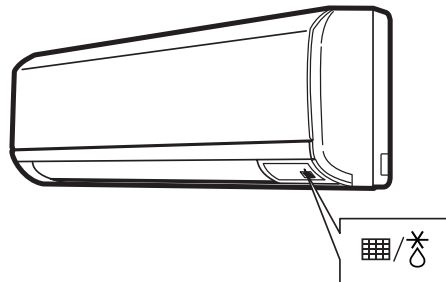
Do not use metallic pins, paper clips, or pens to activate the temporary switch. A failure could occur.

5.2.7 Other Indications



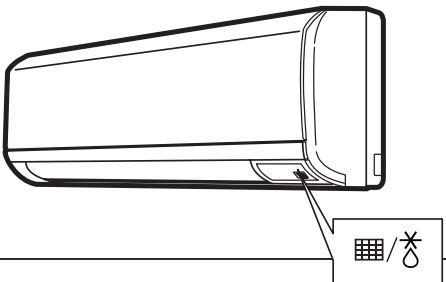







In Normal Condition

Defrost (for Cooling/Heating Unit Only)	<p>Defrost Operation</p> <p>The indicator “” (yellow) is turned ON during the defrosting. The louver is stationary.</p> <p>The louver indication of LCD continues to be activated.</p>	
	<p>Operation Stoppage during Defrosting Operation</p> <p>The indicator “” (orange) is turned OFF when pressing “Off ” switch during the defrosting.</p> <p>The operation continues with the indicator “” (yellow) turned ON, and the unit is stopped after finishing defrost operation.</p>	
Filter	<p>Filter Sign</p> <p>The air filter needs to be cleaned when the indicator “” light turns yellow.</p> <p>This occurs when the operation time has accumulated 200 hours.</p> <p>After cleaning, point the transmitter towards the receiver and press “Reset ” button to turn OFF the indicator “”.</p>	

NOTE:

During heating operation, the fan speed may be changed to low due to air inlet thermistor control. However, the indication is not changed.

In Abnormal Condition

Abnormal	<ul style="list-style-type: none"> The indicator “” (orange) will flash (0.5 second ON / 0.5 second OFF) when a fault is generated or a safety device activates during TEST RUN or normal operation. <p>The type of an alarm code is determined by how many times in sequence it flashes.</p> <div style="text-align: right;"> <p>Example</p> <p>Alarm 3 5</p> <p>↳ “” (yellow light)</p> <p>↳ “” (green light)</p> <p>“” flashes 3 times (0.5 second ON / 0.5 second OFF)</p> <p>“” flashes 5 times (0.5 second ON / 0.5 second OFF)</p> <p>These messages are repeated until the alarm is reset.</p> </div> <table border="1" style="width: 100%; border-collapse: collapse;"> <thead> <tr> <th>Item</th> <th>Indicator</th> <th>Indication Color</th> <th>Flashing Times</th> </tr> </thead> <tbody> <tr> <td>Tens Digit</td> <td style="text-align: center;"></td> <td style="text-align: center;">Green</td> <td>Tens digit is indicated by number of flashing times.</td> </tr> <tr> <td>Unit Digit</td> <td rowspan="2" style="text-align: center;"></td> <td rowspan="2" style="text-align: center;">Yellow</td> <td>Unit digit is indicated by number of flashing times.</td> </tr> <tr> <td>Alphabet</td> <td>Alphabet is indicated by number of flashing times as follows. A...10 times / B...11 times / C...12 times</td> </tr> </tbody> </table>	Item	Indicator	Indication Color	Flashing Times	Tens Digit		Green	Tens digit is indicated by number of flashing times.	Unit Digit		Yellow	Unit digit is indicated by number of flashing times.	Alphabet	Alphabet is indicated by number of flashing times as follows. A...10 times / B...11 times / C...12 times
Item	Indicator	Indication Color	Flashing Times												
Tens Digit		Green	Tens digit is indicated by number of flashing times.												
Unit Digit		Yellow	Unit digit is indicated by number of flashing times.												
Alphabet			Alphabet is indicated by number of flashing times as follows. A...10 times / B...11 times / C...12 times												
Power Failure	<ul style="list-style-type: none"> All the indications are OFF. Once a power failure has occurred, the unit will not restart even though power is restored. Repeat the starting procedure. In the case of instantaneous power failure within 2 seconds, the unit is started again automatically. 														
Electric Interference	<p>A unit shutdown with all indicators OFF is caused by electronic interference (noise). The micro-computer was activated, thus setting the process in motion. Repeat the starting procedure.</p>														

5.2.8 Identifying Indoor Units Installed Side by Side

This function is used when operating several receivers or indoor units side by side, to prevent malfunction from incorrect signals received from the wireless controllers used in other areas.

Only the communication between the paired setting is possible, and four pairs (A, B, C, D) are available. For example, the receiver set as “A” can only receive signals from the wireless controller set as “A”. It cannot receive signals from a wireless controller set as B, C or D.

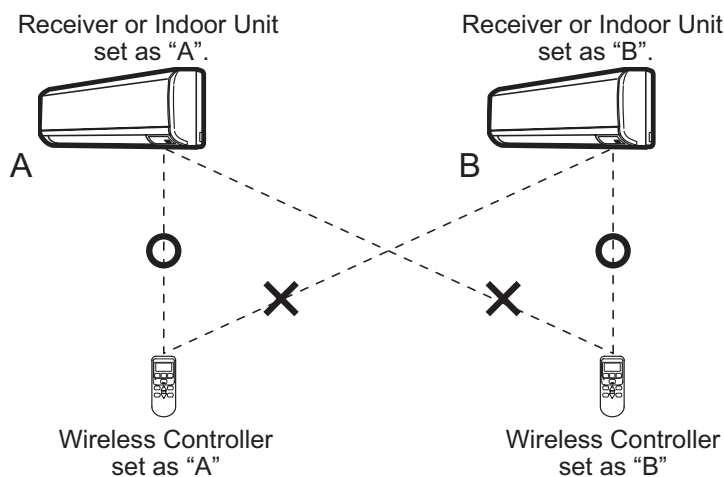

Refer to the “Installation and Maintenance Manual” or the “Operation Manual” for each receiver kit or indoor unit setting. Depending on the type of receiver kit or the indoor unit, only settings A and B are available and not C or D. In that case, set the wireless controller as A or B.

• Procedure for this function

- (1) Press both “On Timer” and “Reset” switches for 3 seconds.
- (2) The current value set for this function is displayed (A, B, C or D).

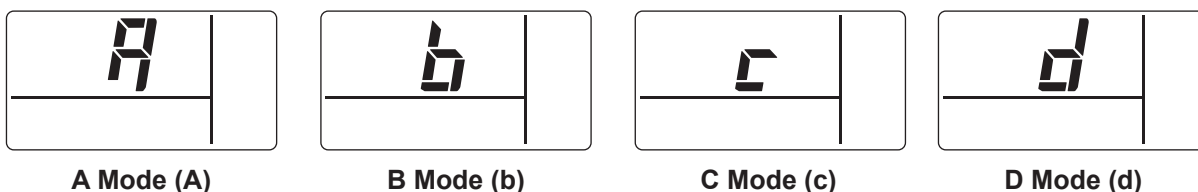

- (3) Press “▽” to change the setting in ascending order. ($\Rightarrow A \rightarrow B \rightarrow C \rightarrow D \Leftarrow$)
 Press “△” to change the setting in descending order. ($\Leftarrow A \leftarrow B \leftarrow C \leftarrow D \Leftarrow$)

NOTE:

The setting is recorded each time “▽” or “△” switch is pressed.

- (4) Press “Off ○” switch to exit this function and reset.

NOTE:

If no operation is performed 30 seconds after this function is displayed, it will automatically end and reset.

5.2.9 Handling Wireless Controller

- Point the transmitter towards the receiver.
The distance for transmitting is approximately 16.4ft (5m) maximum. (The distance for transmitting shortens if the transmitting angle is not vertical to the receiver or if there is other electronic interference in the room.)
Maintain a minimum of 3.3ft (1m) distance between the indoor unit and light fixtures.

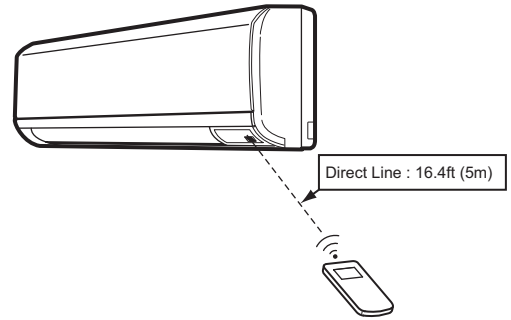

- Before installation of the indoor unit, ensure that the receiver can correctly receive commands from the wireless controller.
- Handle the wireless controller with care. It is fragile and susceptible to damage by moisture.

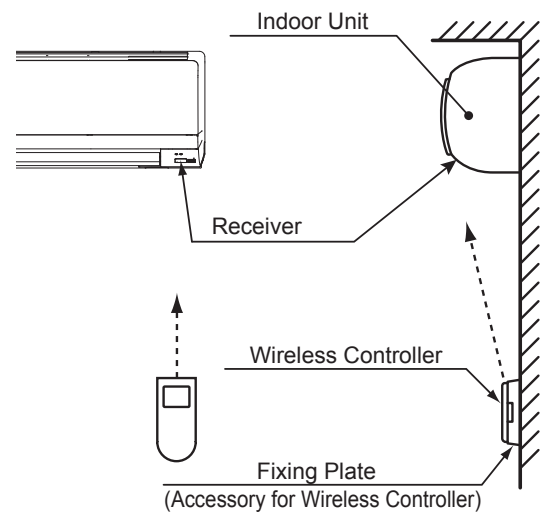

6. Automatic Control

This air conditioner automatically starts the following operations according to the indoor conditions.

The system is equipped with the following functions.

3-Minute Guard		<ul style="list-style-type: none"> ▪ Enforced Stoppage: The compressor remains off for at least 3 minutes once it has stopped. If the system is started within approximately 3 minutes after it has stopped, the RUN indicator is activated. However, the cooling operation or the heating operation remains off and does not start until after 3 minutes has elapsed. ▪ Enforced Operation: If all indoor units of the system are Thermo-OFF within approximately three minutes after the compressor has started, the compressor operates continuously during those 3 minutes. However, if all indoor units of the system are stopped by a controller, compressor has stopped.
Cooling and Dry	Frost Prevention	When the indoor unit is operating at a low discharge air temperature, the cooling operation may be changed to fan operation for a while to avoid frost formation on the indoor heat exchanger.
	Self-Cleaning of Expansion Valve	The expansion valve self-cleans when the cooling operation has stopped. The sound of the refrigerant flow may be heard from the indoor unit during the self-cleaning. This is not abnormal.
	Condensate Prevention	To prevent condensation, the unit operates with its louver at a different angle from the specified setting for a certain period of time. Even in this case, the LCD of the wireless controller indicates the specified louver angle.
	Fan Operation during Power Saving Control	When the power saving operation is performed, the louver control is changed to auto mode or fixed downward angle. The LCD on the wireless controller indicates it has not changed.
Heating	Hot Start	To prevent cold air discharge in the room, the fan speed is controlled from the slow position and the low position and then to the set position according to the discharge air temperature. At this time the louver is fixed horizontally and "HOT-START" is displayed on the LCD of the wired controller.
	Defrost Operation	The indoor unit fan operation is stopped to prevent cold air discharge during the defrost operation. At this time, the indication "HOT-START" is displayed on the LCD of the wired controller and the indoor unit fan louver angle is set horizontally.
	Residual Heat Removal	When the heating operation is stopped, the indoor fan operation may remain at the slow speed for a maximum of two minutes to lower the internal temperature of indoor unit.
	Prevention of Overload Operation	When the outdoor temperature is high (approx. 70°F (21°C) or more) during the heating operation, the operation is stopped by activation of the outdoor thermistor.

NOTE

- This air conditioner adopts a hot air circulation system for the heating operation. If the space is large or the room temperature is excessively low, it takes time to heat the entire room. If the room is heated enough and discharged air reaches a required temperature, the indication "HOT-START" is turned OFF after heating the room.
- The indication "HOT-START" may be displayed during, or right after, the defrosting operation. "HOT-START" is activated during defrost to ensure comfort by reducing the delivery of cold air in the heating cycle. This is NOT abnormal.

7. Maintenance

! WARNING

- Turn OFF the power source before the maintenance work. If the power source is not turned OFF, the result may be electrical shock or fire.
- Perform the maintenance work with a stable foothold or foundation. This may prevent falling or injury.

! CAUTION

- When the flat panel is opened (closed) or the air filter is attached (removed), hold them firmly. If not, it may cause falling or injury.

NOTICE

Do not operate the system without the air filter to protect the indoor unit heat exchanger against being clogged.

7.1 Daily Maintenance

7.1.1 Cleaning Air Filter

Clean the air filter when the filter sign is turned ON.

CIW01

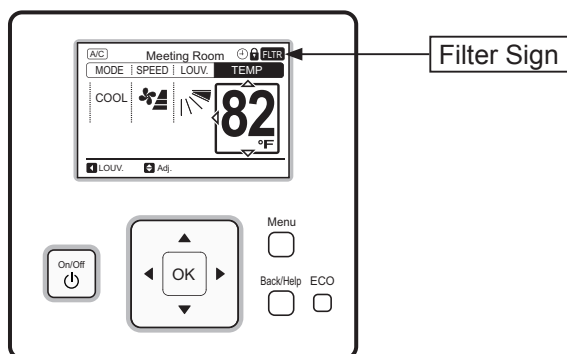

CIR01

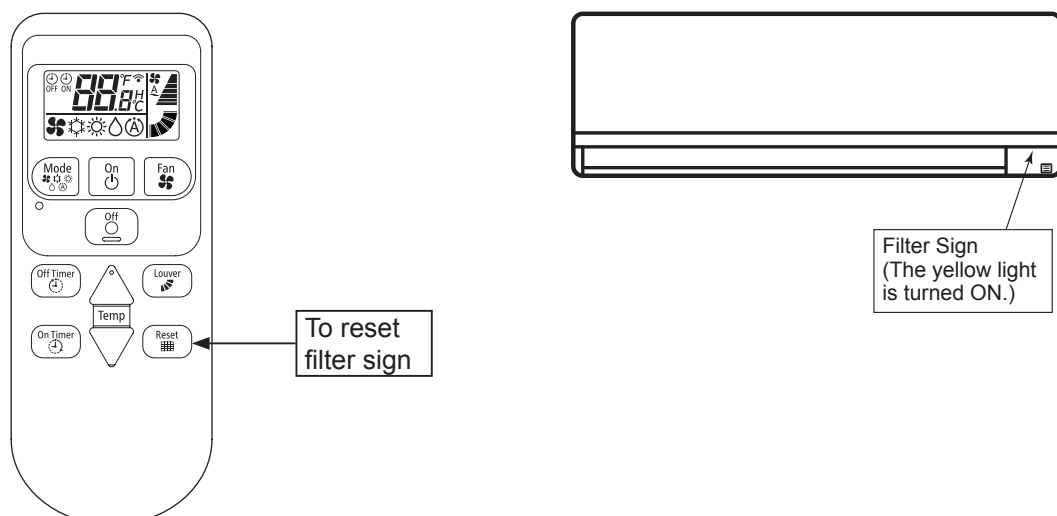

- (1) Open the flat panel.
Hold both sides of the flat panel and lift it up.

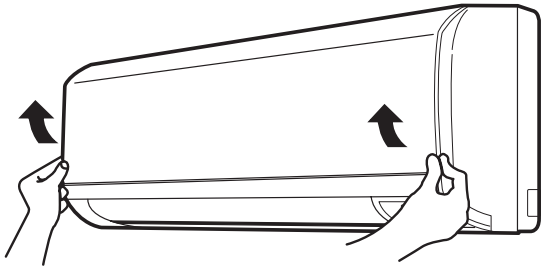

- (2) Remove the air filter.
Release the two (2) catches and pull the air filter downward to remove it.

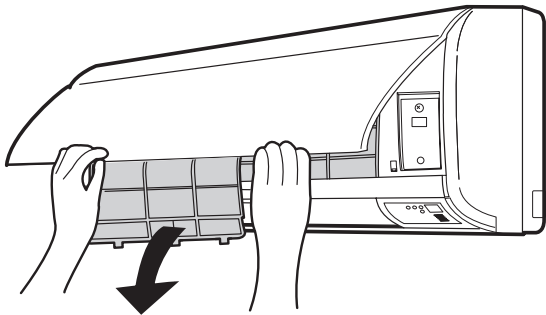

CAUTION

Raise the flat panel until it locks into open position. Otherwise, the flat panel closes and it may cause injury.

- (3) Clean the air filter.
 - Wash the filter with mild soap and warm water or vacuum-clean.
 - Dry the air filter in the shade.

NOTE

- Do not use water warmer than 122°F (50°C). Air filter element can be damaged.
- Do not dry the air filter by holding it over open flame, with a hair dryer, or any type of heating device. Filter elements can be damaged by heat.

- (4) Attach the air filter.
After the air filter is cleaned with water and dried, reattach with the “FRONT” indicators in the proper position.

NOTICE

Be sure to attach the air filter.
If the indoor unit is operated without the air filter, it may cause malfunction of the indoor unit.

- (5) Reset the filter sign.

CIW01

NOTE

If the default time period for filter cleaning has not been set, the indication “☒” appears and “Setting Disabled” is displayed.

- Press “Menu”.
Select “Reset Filter Sign Time” from the menu and press “OK”.
The confirmation screen is displayed.

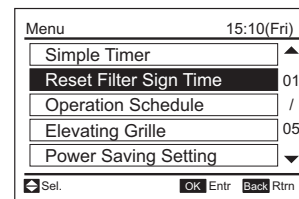

- Select “Yes” by pressing “◀” or “▶” and press “OK”.
The “FLTR” indication is turned OFF and the screen will return to the normal mode.

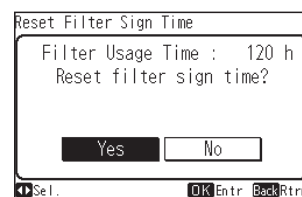

CIR01

Point the transmitter toward the receiver and press “Reset” switch. The filter sign of unit is turned OFF and the time before the next filter cleaning starts accumulating.

NOTICE

- Gently wipe down using only a clean soft cloth. Using Benzene type thinners or chemical detergents and abrasives as cleaning agents can damage the finish of plastic surfaces and louvers. In addition, pay attention that the parts around the air outlet (louver, guide, etc.) may be damaged if an excessive force is applied.
- The flat panel can be removed using both hands and cleaned.

TIWM006B22S to TIWM012B22S

(1) Removing Flat Panel

Hold both ends of flat panel and open it fully. After the right arm shaft is expanded outward and shafts are removed from the front panel, pull the flat panel forward while the right arm shaft is expanded outward.

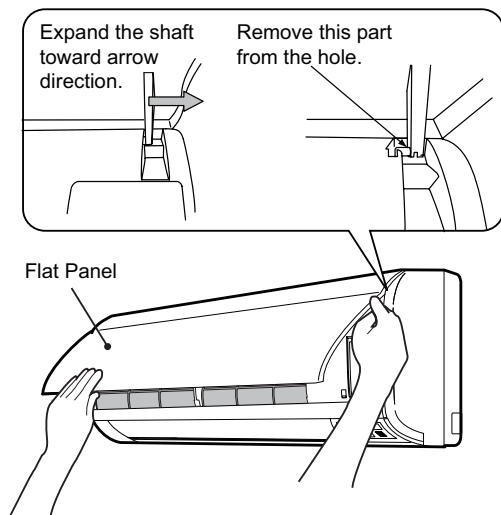

(2) Attaching Flat Panel

Insert both support arms into the recessed openings and close the lid. Check that the flat panel is attached completely, and close the flat panel.

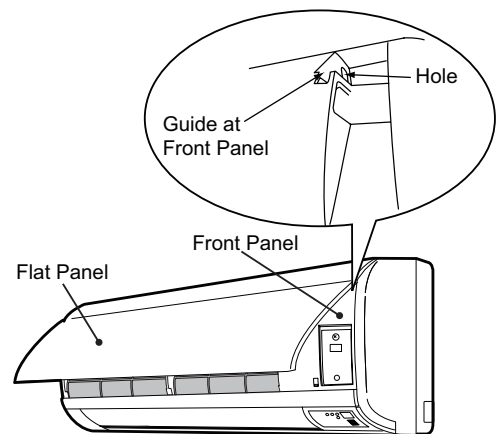

TIWM015B22S to TIWM030B22S

(1) Removing Flat Panel

Hold both sides of flat panel and open it fully. After the right arm shaft is pushed inward and shafts are removed from the front panel, pull the flat panel forward while the right arm shaft is slightly pushed inward.

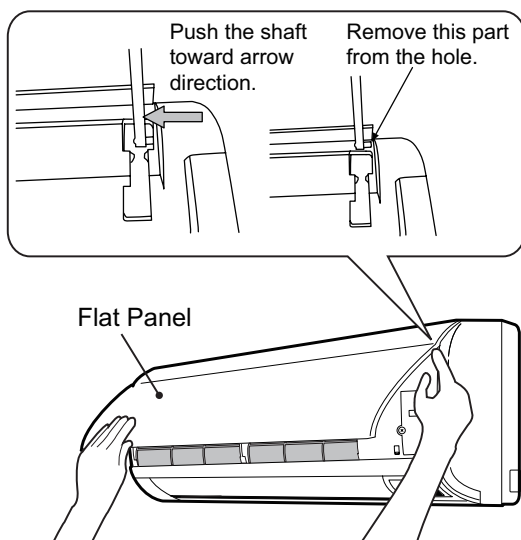

(2) Attaching Flat Panel

Insert both support arms into the recessed openings and close the lid. Check that the flat panel is attached completely, and close the flat panel.

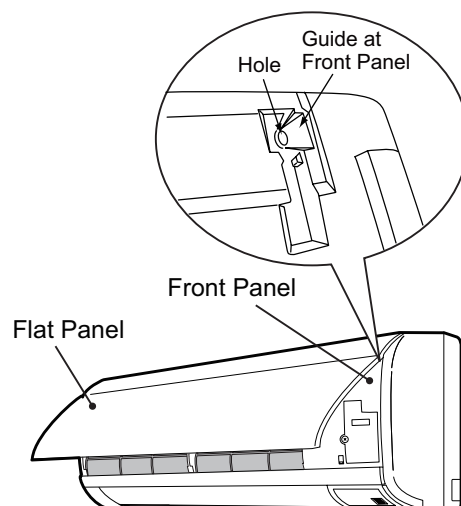

7.2 Maintenance Prior to and After Use

Prior to Use

- Remove any obstacles around the air inlet grilles and the air outlet of the indoor unit and outdoor unit.
- Check that the air filter is not clogged with dust and dirt.

After Use

- Clean the air filter, the air inlet grille and the flat panel.

7.3 Replacing Batteries (CIR01)

Under the normal use, battery life should be about 1 year (in the case of alkaline batteries).

Replace the batteries if the following phenomenon occurs:

The transmission distance between the wireless controller and the receiver gets shorter for operation or fan speed adjustment.

- (1) Remove the battery cover by sliding it in the direction of the arrow by pushing the cover apart as shown in the figure below.
- (2) Set the batteries.
(Insert the batteries according to the marks + and - on the case.)

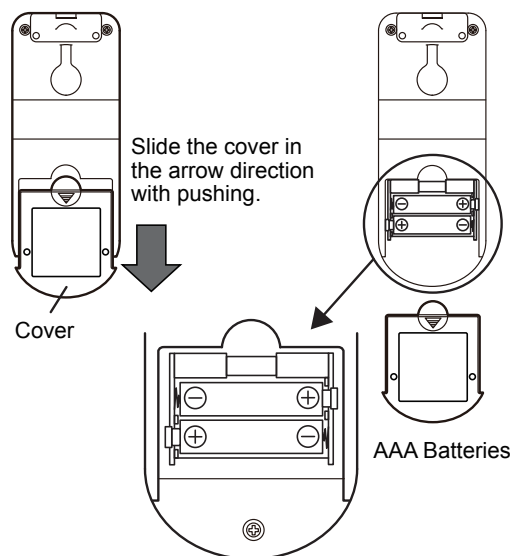

NOTES:

- Follow these precautions for battery use.
 1. Never use the new and used batteries together.
 2. Never use different types of batteries (for example manganese battery and alkaline battery) together.
 3. When the wireless controller is not used for a long time (more than 2 or 3 months), remove the batteries.
- When the batteries are replaced, wait at least 5 seconds before installing new batteries.
- All settings are reset after batteries are replaced. Therefore, when "Identifying Indoor Units Installed Side by Side" is set, this setting is cancelled once the batteries are replaced. After replacing the batteries, set the "Identifying Indoor Units Installed Side by Side" command.
(Press and hold "On Timer" and "Filter Sign Reset" simultaneously for 3 seconds. The current value set for this function is displayed (A, B, C or D). Refer to Section 5.2.8 for details.)

8. Troubleshooting

8.1 This is Not Abnormal

Phenomenon		Cause and Action
Operation Stopped	All indication lamps on the wired controller are turned OFF.	The micro-computer is activated to protect the device from electromagnetic waves. Restart the operation.
	After Power Failure	Restart the operation. If the instantaneous power failure is within two seconds, the operation restarts automatically.
White Steam from Indoor Unit	During Heating Operation	Dust attached to the heat exchanger has dried.
White Smoke from Indoor Unit	At Beginning of Heating Operation Season	This might occur when dust attached to the heat exchanger has dried.
Mist from Indoor Unit	In Restaurant or Kitchen	This might occur when oil attached to the fins might decrease the heat exchange efficiency.
	During Dry Operation	This might occur when the air outlet temperature becomes lower. Change the operation mode.
	During Cooling Operation in Humid Environment	This might occur when the air outlet temperature becomes lower. Raise the set temperature and the air flow volume.
Odor from Indoor Unit	Odor Discharged from Indoor Unit	This might occur when the smell of cigarette smoke infiltrated the inside of the indoor unit. Ventilate the unit well in the fan mode and clean the air filter, the air outlet and the air inlet grille.
Sound from Indoor Unit	Grate is heard when starting or stopping the operation.	This is the sound made when the components are rubbing against each other due to the extension and contraction of the resin parts caused by the temperature change.
	Sound of water flowing or bubbling during the operation.	This is the sound made when the refrigerant flows or the drain-up mechanism drains water. The sound may be heard especially when starting the operation or stopping the compressor (for approx. 3 minutes).
	Growling sound may be heard temporarily right after the air flow volume is changed.	It is generated because the fan motor makes temporary sound by change of fan speed.
Condensation on Front Panel	Condensation on front panel or cabinet or condensation drips	This might occur when the operation is performed in humid location (relative humidity is approximately 80%) over a prolonged period of time.
Temperature Irregularity	The air flow volume and temperature of each air outlet are irregular.	This might occur for structural reasons, such as the size of air outlet and the location of heat exchanger.
“HOT-START” on LCD Turned ON		This might occur according to the operation mode or operation conditions.
Operation Mode on LCD Flashing		

8.2 Before Contact

Refer to the information below before contacting a contractor.

Trouble		Check Point	Action
Operation Unavailable		Check that the main power source is turned ON.	Turn ON the main power source for the air conditioner.
		Check that the fuse is not blown out or the circuit breaker of the main power source tripped.	Replace the fuse or reset the circuit breaker. If the trouble recurs, contact your contractor or distributor.
Immediate Shutdown after Start-up	Cooling	Check that the air inlet and outlet of the outdoor unit are not covered with paper, vinyl or other objects.	Remove objects covering the air inlet and outlet.
	Heating	Check for any obstacles preventing the air flow near the air inlet and outlet of the outdoor unit.	Remove the obstacles preventing the air flow.
		Check that the outlet air is not short-circuited to the air inlet.	
Insufficient Cooling or Heating		Check that the operation mode is correct.	If the fan mode is selected, switch the operation mode to cooling or heating.
		Check that the set temperature is correct.	If not, change the set temperature by pressing “Δ” or “∇” by the wired controller.
		Check that the air flow direction is correct.	If not, change the air flow direction. In the case that the footing is not heated well during the heating operation, change the louver downward.
		Check that the air filter is not clogged.	Clean the air filter.
		Check that a window or a door is not opened.	Close the window or the door.
		Check for any obstacles preventing the air flow near the air inlet and outlet of the indoor and outdoor units.	Remove the obstacles.

8.3 Contact Distributor

If problem still remains even after checking previous issues or other problems not mentioned in the previous issues occur, stop using the product and contact your distributor or contractor.

! WARNING

If an abnormality such as a burnt odor or something similar occurs, stop the operation and turn OFF the main power source immediately. If the power source is not turned OFF, there may be damage of the product, an electric shock or a fire. Contact your distributor or contractor.

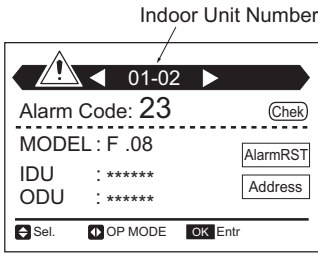
Trouble	Action before Contacting Contractor or Distributor
The protection devices (fuse, breaker, GFCI, and so forth) are frequently activated or the operation switch does not work.	Turn OFF the power source.
Water Leakage from the Indoor Unit.	Stop the operation.
<ul style="list-style-type: none"> The RUN indicator (red) is flashing. The indoor unit number, the alarm code, the unit model code and the number of connected indoor units are displayed on the LCD. If multiple indoor units are connected to one controller, the above abnormality informations for each indoor unit is displayed individually. <p>Check the details on the LCD and contact your distributor.</p> <p>CIW01</p> <div style="text-align: center;">  <p>The screenshot shows an LCD display with a warning icon and the text 'Indoor Unit Number' pointing to '01-02'. Below this, it displays 'Alarm Code: 23' with a 'Check' button, 'MODEL: F .08', 'IDU : *****' with an 'AlarmRST' button, and 'ODU : *****' with an 'Address' button. At the bottom, there are navigation buttons: 'Sel.', 'OP MODE', and 'Entr'.</p> </div> <p>CIR01</p> <p>The type of an alarm code is determined by number of times the indicator on the indoor unit flashes.</p>	<p>Refer to Section 8.4, the alarm code table. Contact your distributor and advise the indication detail on the wired controller.</p>

Provide the following information when contacting your distributor.

- 1) Unit Model
- 2) Explain the Trouble or Problem
- 3) Alarm Code No. on the LCD or Details of a Flashing Indicator

8.4 Alarm Code

Code	Category	Content of Abnormality	Code	Category	Content of Abnormality
01	Indoor Unit	Activation of Protection Device	35	System	Incorrect Setting of Indoor Unit No.
02	Outdoor Unit	Activation of Protection Device (High Pressure Cut)	36		Incorrect Indoor Unit Combination
03	Communication	Operational Irregularities between Indoor and Outdoor	38		Problem with Protective Pickup Circuit in Outdoor Unit
04		Problem between Inverter PCB and Outdoor PCB	39	Compressor	Problem with Running Current at Constant Speed Compressor
05	Supply Phase	Problem of Power Source Phases	41	Pressure	Overload Cooling
06	Voltage	Abnormal Voltage Drop in Outdoor Unit	42		Overload Heating
07	Cycle	Decrease in Superheated Discharge Gas	43	Protection Device	Activation of Pressure Ratio Decrease Protection Device
08		Increase in Discharge Gas Temperature	44		Activation of Low Pressure Decrease Protection Device
09	Outdoor Unit	Activation of Protection Device for Outdoor Fan	45		Activation of Low Pressure Increase Protection Device
11	Sensor on Indoor Unit	Inlet Air Thermistor Failure	46		Activation of High Pressure Increase Protection Device
12		Outlet Air Thermistor Failure	47		Activation of High Pressure Decrease Protection Device
13		Freeze Protection Thermistor Failure	48	Activation of Overcurrent Protection Device	
14		Gas Piping Thermistor Failure	51	Inverter	Problem with Inverter Current Sensor
19	Fan Motor	Activation of Protection Device for Indoor Fan	52		Activation of Inverter Overcurrent Protection
20	Sensor on Outdoor Unit	Compressor Thermistor Failure	53		Activation of Transistor Module Protection
21		High Pressure Sensor Failure	54	Abnormality of Inverter Fin Temperature	
22		Outdoor Air Thermistor Failure	56	Outdoor Fan	Abnormality of Detection for Fan Motor Position
23		Discharge Gas Thermistor Failure	57		Activation of Fan Controller Protection
24		Evaporating Thermistor Failure	58		Abnormality of Fan Controller
29		Low Pressure Sensor Failure	b0	System	Incorrect Setting of Unit Capacity
31	System	Incorrect Capacity Setting of Outdoor Unit and Indoor Unit	b1		Incorrect Setting of Unit and Refrigerant Cycle No.
32			Incorrect Setting of Other Indoor Unit Number	EE	Compressor

